

# C 015

## Circular connectors



# Note from the CEO



## Ladies and Gentlemen,

For over 75 years Amphenol has enjoyed success as the interconnection technology provider of choice to industry-leading companies around the world. One of our key strategic areas of focus has been and is the Industrial market. Our organization works with leading manufacturers across a wide range of applications - including Energy Generation & Distribution, Transportation, Heavy Equipment, Factory Automation, Wireless Outdoor, ChipCard Readers - enabling smarter, faster and better technologies to connect products to customer solutions.

The Industrial market footprint of Amphenol covers over facilities in more than 12 different European countries and more than 30 countries worldwide. Our successful expansion into new regions as well as new industrial applications is a direct reflection of our agile, entrepreneurial management team and our unwavering commitment to execute Amphenol's strategies for the benefit of our customers, shareholders and employees.

Thank you for partnering with Amphenol. Our entire organization is at your service.

A handwritten signature in black ink, appearing to read 'R. Adam Norwitt'. The signature is fluid and cursive, with a long horizontal stroke at the end.

R. Adam Norwitt  
President and CEO, Amphenol Corporation



# Make use of the best

## Use our global resources

“Think global, act local!” Independently from where you are in Europe, we offer you our global expertise and great variety of products and technologies. And in comfort with your personal contact. Our numerous European offices are your access to our global resources.

© OUR OFFICES IN EUROPE AND WORLDWIDE

---

- |                |        |           |              |
|----------------|--------|-----------|--------------|
| FRANCE         | CHINA  | AUSTRALIA | SOUTH AFRICA |
| GERMANY        | KOREA  | MEXICO    | INDIA        |
| UNITED KINGDOM | TAIWAN | USA       | ITALY        |

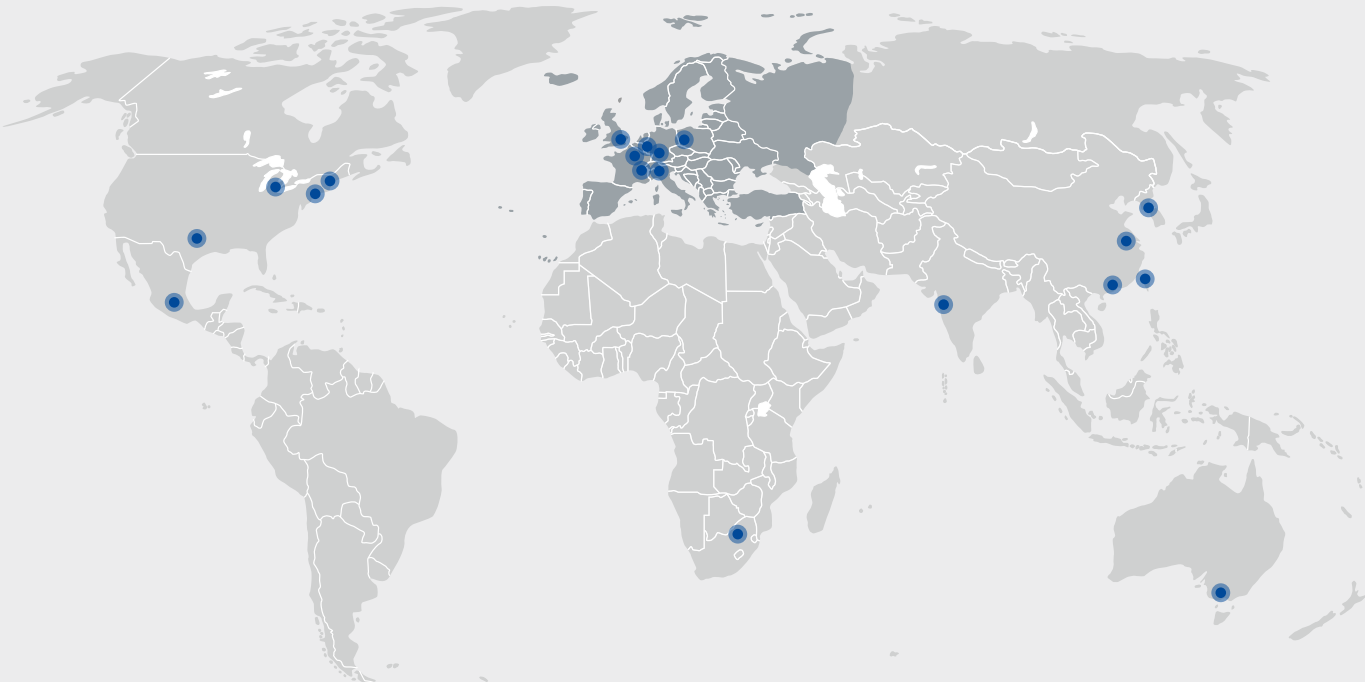



SECURITY, RELIABILITY AND COMFORTABLE SERVICE FROM ONE SOURCE.

# More time for important things: benefit from our service and diversity

Enjoy security, reliability and comfortable service from one source. INDUSTRIAL@AMPHENOL offers one of the most individual and most diversified service programmes in the market – exclusively for industrial customers. Access all possibilities of the Amphenol group through your personal expert adviser.



## WIDE PRODUCT RANGE

Take advantage of a choice of Amphenol products. Our broad product portfolio offers individual solutions from more than 85 member companies in the global Amphenol group.



## EXCLUSIVENESS AND FLEXIBILITY

One face to the customer: every inquiry is handled on an individual service level by your personal key account service partner. This ensures maximum transparency and best-in-class flexibility in the whole process.



## QUALITY

Interconnect systems need reliability, speed and flawless data transmission. We continuously test and guarantee the required standard in our products – and also in our personal services.



## INDIVIDUAL SOLUTIONS

Your project requires an individual solution that is not available off-the-shelf? As your think tank and discussion partner we provide engineering support and solution-oriented development for your tailor-made Amphenol product.



## SPEED AND AVAILABILITY

Smart and intelligent processes are the secret behind our service programme. Flexible planning and distribution, perfect logistics and highest availability are our key factors for best customer service.



## GLOBAL KEY ACCOUNT SERVICE

Our key account service is your individual entrance to global know-how, products and services. More than 85 Amphenol companies around the world offer an extensive range of technologies and products. We offer access to our worldwide resources through one individual contact person.

**CIRCULAR CONNECTOR ACCORDING EN 175 000 (DIN 43 563)**

The six- and seven-pole circular connectors of the C 015 series are according to the requirements of EN 175 000. The series is distinguished by its stable design and easy handling. They are also compatible with connectors according to MIL-C-5015 of housing size 14S. Their main applications are continuous and proportional valves as well as measuring and control instrumentation.

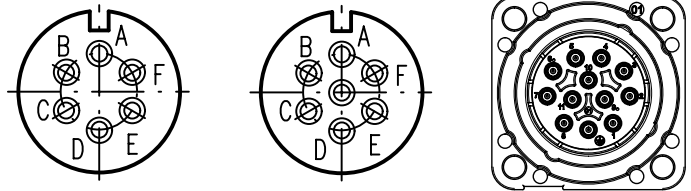

Number of poles	Standard	6	6 + PE	11 + PE
Rated voltage	IEC 60664-1	150 VDC		25 VAC / 50 VDC
Rated surge voltage	IEC 60664-1	2500 V		800 V
Degree of contamination	IEC 60664-1	3		
Overvoltage category	IEC 60664-1	3		
Current-carrying capacity	IEC 60664-5-2	0,5 mm <sup>2</sup> , 6 A, +70 °C ambient temperature 1,5 mm <sup>2</sup> , 9 A, +70 °C ambient temperature		5 A, +40 °C ambient temperature
Termination technique		Cable connector: crimping /soldering; Receptacle: soldering, dip soldering		Dip solder
Connection cross section		Cable box: 0.14-0.5 mm <sup>2</sup> , 0.5-1.5 mm <sup>2</sup> ; Device connector: max. 1.5 mm <sup>2</sup>		n.a.
Contact surface		Ag		Au
Temperature range in operation		-40 °C / +100 °C		
Temperature range during assembly		-20 °C / +100 °C		
Test class	IEC 60068-1	40 / 100 / 56		
Interlock		Screws, tightening torque 1.5 Nm - 2.0 Nm		
Protection class	IEC 60529	IP 65		
Contact resistance	IEC 60512-2-1	≤ 5 mΩ		
Insulation resistance	IEC 60512-3-1	≤ 10 <sup>9</sup> Ω		
Contact carrier/Housing material		PA 6.6, fire behavior / (UL 94): V-O		
Housing/Locking ring material		Al		Die-cast zinc
Mechanical life time	IEC 60512-9-1	≥ 500 mating		
Total insertion force	IEC 60512-13-1	50 N		
Total pulling force	IEC 60512-13-1	50 N		

## C 015 Straight and right-angled cable connectors

### FEMALE CABLE CONNECTOR

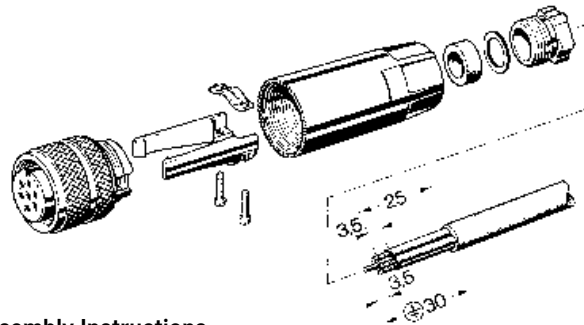

Assembly Instructions

Description	Customer drawing	Number of poles	Order number		Crimp termination
			Solder termination silver	Solder termination gold	
Female cable connector cable diameter: 8-10 mm		6 + PE	C 015 30D006 001 1	On request	C 015 10D006 001 1 <sup>1</sup>
		6 pol.	C 015 30D006 001 2	On request	C 015 10D006 001 2 <sup>1</sup>
Female cable connector cable diameter: 10-12 mm		6 + PE	C 015 30D006 002 1	On request	C 015 10D006 002 1 <sup>1</sup>
		6 pol.	C 015 30D006 002 2	On request	C 015 10D006 002 2 <sup>1</sup>

### ANGLED CONNECTORS

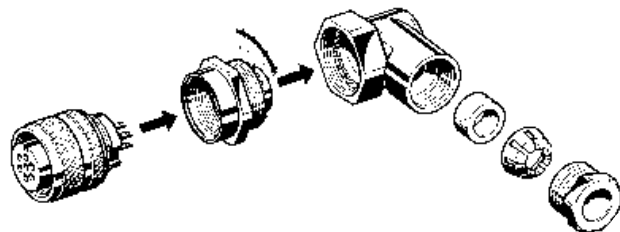

Assembly and dimensioned drawing

Description	Customer drawing	Number of poles	Order number		Crimp termination
			Solder termination silver	Solder termination gold	
Female cable connector cable diameter: 8-10 mm		6 + PE	C 015 30 F006 001 1	On request	C 015 10 F006 001 1 <sup>1</sup>
		6 pol.	C 015 30 F006 001 2	On request	C 015 10 F006 001 2 <sup>1</sup>
Female cable connector cable diameter: 10-12 mm		6 + PE	C 015 30 F006 002 1 <sup>1</sup>	On request	C 015 10 F006 002 1 <sup>1</sup>
		6 pol.	C 015 30 F006 002 2 <sup>1</sup>	On request	C 015 10 F006 002 2 <sup>1</sup>

Processing tools and crimp contacts on request.

<sup>1</sup>Please order crimp contacts separately. See page 8.

## C 015 Male receptacle and crimp contacts for female cable connector

### MALE RECEPTACLE



With flat sealing

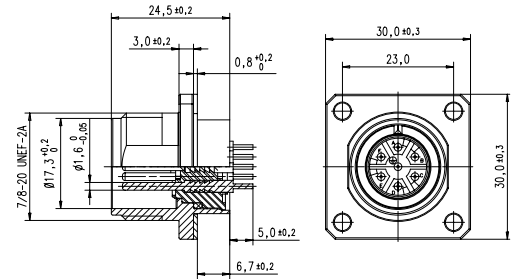

Description	Number of poles	Order number			
		Solder termination		Crimp termination	Dip solder termination
		silver	gold		
Device connector, dip solder connection	6 + PE	C015 50C006 100 1	-	-	-
	6 pol.	C015 50C006 100 2	-	-	-
Device connector, solder connection	6 + PE	C015 30C006 100 1	-	-	-
	6 pol.	C015 30C006 100 2	-	-	-
Device connector, plug contacts	II + PE	-	-	-	C015 50C0118001

### CRIMP CONTACTS FOR FEMALE CABLE CONNECTORS



Description	Contact diameter	Cross section	Packing unit	Pieces	Part number	Crimp tool
Socket contacts, contact surface silver	1,6 mm	0,14-0,5 mm <sup>2</sup>	Single contact	100	VN02 016 0003 (1)	TA 0700 203
			Strip contact	200	ZN02 016 0003 (1)	TA 0100 146
				2000	HN02 016 0003 (1)	-
		0,5-1,5 mm <sup>2</sup>	Single contact	100	VN02 016 0002 (1)	TA 0000 + TA 0000 163 + TA 0002 146 0001
			Strip contact	200	ZN02 016 0002 (1)	TA 0700 309
				2000	HN02 016 0002 (1)	-





## 6+PE female cable connector

- Suitable for all standard applications
- According EN 175 000 (DIN 43 563)
- Compatible with plug connector ACE MIL-C-5015 size 14S

### Applications

- Continuous and proportional valves
- Measuring and control instrumentation
- Directional control valves
- ...



TECHNICAL DATA

General characteristics values	Standard	Values
Number of poles		6+PE
Degree of contamination	IEC 664	3
Overvoltage category	IEC 664	III
Insulating material	IEC 664	II
Test voltage	IEC 664	1390 V
Current-carrying capacity	IEC 512-3	0,5mm <sup>2</sup> , 6 A, +70°C ambient temperature 1,5mm <sup>2</sup> , 9 A, +70°C ambient temperature
Insulating resistance	IEC 512-2	≥10 <sup>8</sup> Ω
Contact resistance	IEC 512-2	≤5 Ω
<b>Parts numbers</b>		
Single female cable connector	<b>C015 30D006 802 1</b>	
Female cable connector with unshielded 6m cable	<b>CA015 12 0 100 006</b>	
Female cable connector with unshielded 3m cable	<b>CA015 12 0 100 003</b>	

DERATING CURVE

Data according to DIN JEC 5 12 T3 all contacts in series plug connector 6+PE

**Cross section 0,5 mm<sup>2</sup>**

**Cross section 1,5 mm<sup>2</sup>**

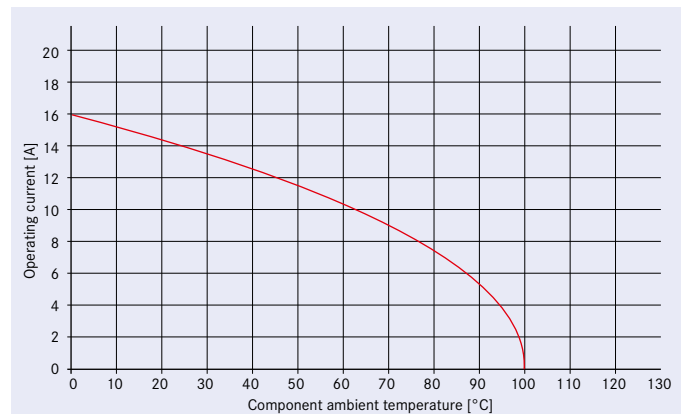
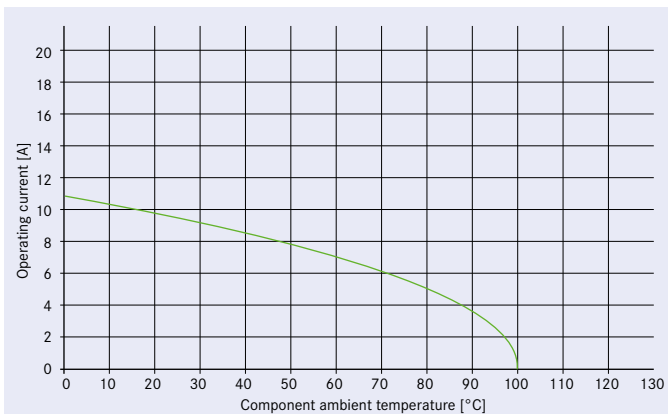

**11+PE available on request**



## International

### Argentina

Amphenol Argentina  
Av. Callao 930  
2nd Floor Office B "Plaza"  
C1023 AAP Buenos Aires  
Phone +54 11 4815 68 86  
www.amphenol.com.ar

### Australia

Amphenol Australia Pty. Ltd.  
2 Fiveways Blvd  
Keysborough  
Victoria 31 73  
Phone +61 3 8796 88 88  
www.amphenol.com.au

### Brazil

Amphenol do Brasil Ltda.  
Rua Diogo Moreira 132, 20th Floor  
CEP 05423-101 Sao Paulo SP  
Phone +55 11 3815 10 03  
www.amphenol.com.br

### China

Amphenol-Tuchel Electronics  
China Branch  
20 Tianshan Road  
Changzhou 213022  
Phone +86 519 85 11 03 01  
www.amphenol.info

### France

Amphenol Socapex S.A.S.  
948, Promenade de l'Arve, BP 29  
Theyez Cedex, 74311  
Phone +33 4 5089 28 00  
www.amphenol-socapex.com

### Germany

Amphenol Tuchel Industrial GmbH  
August-Haeusser-Str. 10  
74080 Heilbronn  
Phone +49 7131 929 0  
www.amphenol-industrial.de

### India

Amphenol Interconnect India Pvt Ltd  
105, Bhosari Industrial Area  
Pune - 411 026  
Phone +91 20 2712 04 81  
www.amphenol-in.com

### Italy

Amphenol-Tuchel Italy  
Via Barbaiana n. 5  
20020 Lainate (MI)  
Phone +39 02 9325 41  
www.amphenol.info

### Korea

Amphenol DaeShin Elect and  
Precision Co.,Ltd  
558 Songnae-Dong, Sosa-Gu  
Bucheon-City, Kyunggi-Do  
Korea 422-130  
Phone +82 32 6103 800  
www.amphenol.co.kr

### Mexico

Amphenol Mexico  
Prolongacion Reforma 61 - 6 B2  
Col. Paseo de las Lomas  
C.P. 01330 Mexico D.F.  
Phone +52 55 5258 99 84  
www.amphenolmexico.com

### Singapore

Asia Pacific Sales Operations  
72 Bendemeer Rd, No.03-32/33  
Hiap Huat House, Luzerne, 33994 1  
Singapore  
Phone +65 6294 2128  
www.amphenol.com

### South Africa

Amphenol International Ltd  
Chislehurst  
30 Impala Road  
2196 Chislehurst  
Sandton, 2146  
Phone +27 11 7839 517  
www.amphenol.co.za

### Spain

Amphenol Espana  
Edificio Burgosal, Oficina 55  
C/Comunidad de Madrid, 35 bis  
Las Rozas (Madrid), 28230  
Phone +34 91 6407 302  
www.amphenol.com

### Taiwan

Amphenol East Asia Limited-Taiwan  
5F, No. 361, Fusing 1st Rd  
Gueishan Township,  
Taoyuan County 333  
Phone +886 3 2647 200  
www.amphenol.com

Amphenol LTW Technology Co., Ltd.  
9F, No. 657-12, Zhongzheng Road  
Xinzhuang Dist., New Taipei City  
242 Taiwan  
Phone +886 2 2908 5626  
sales@ltw-tech.com  
www.amphenolltw.com

### Turkey

Amphenol Turkey  
Sun Plaza Kat: 15  
Maslak Mah. Bilim Sok.No:15  
34398 Sisli - Istanbul  
Phone: +90 2123 679 220  
www.amphenol.com.tr

### United Kingdom

Amphenol Limited  
Thanet Way, Whitstable  
Kent, CT53JF  
Phone +44 1227 773 200  
www.amphenol.co.uk

### USA

Amphenol-Tuchel Electronics /  
Amphenol Sine Systems  
44724 Morley Drive  
48036 Clinton Township, MI  
Phone +1 586 913 8630  
www.amphenol.info

Amphenol Corporation  
Corporate Headquarters  
358 Hall Avenue  
Wallingford, CT 06492  
Phone +1 877 2674 366  
Phone +1 203 2658 900  
www.amphenol.com

More Amphenol companies can be  
found here: [www.amphenol.com](http://www.amphenol.com)



### Important Notice

All technical data have been measured in a laboratory environment and can be different during practical usage of the product. Any product information is for descriptive usage only and not legally binding; particularly the information does not constitute or provide any legal guaranties ("Beschaffensgarantie" or "Haltbarkeitsgarantie").

We reserve the right to change the design due to improvement in quality, development or production requirements. This catalogue must not be used in any form or manner without our prior approval in writing (Copyright Law, Fair Trading Law, Civil Code).

Your engineering sales  
representative:

