

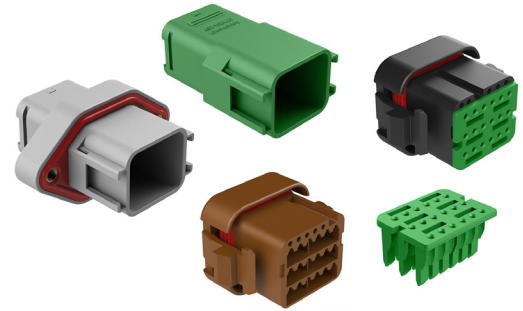

ATV Series™



18 Position Heavy Duty Connectors

The ATV Series™ connectors further expands the proven reliability of the AT Series™ with a compact 18 position sealed flange design. The durable thermoplastic housings feature built-in contact sealing to eliminate individual wire-sealing grommets, while an integral interfacial seal protects mated connectors. The ATV Series™ is perfectly suited to on and off highway applications, marine, industrial, and agriculture markets in harsh environments.

Key Features

- 18 Position cavity arrangement
- Rectangular, thermoplastic housing
- Accepts contact size 16 (13A)
- 14-22AWG
- Flange Mount or In-line (Flangeless) Capability
- Integrated latch for mating
- Integrated wedgelock confirms contact alignment/retention
- Available in custom color options



Housings	Thermoplastic
Seals	Silicone Elastomer
Secondary Locks	Thermoplastic
Contacts	Copper Alloy, Nickel Plated, Gold optional
Temperature	Operating temperature range: -55°C to +125°C at rated current
Dielectric Value	Meets or exceeds 1500 volts minimum
Drop Test	Shall not become detached or loosened when placed at 750mm and dropped to concrete eight times.
Shock	No latch disengagement or discontinuity shall be the result when subjected to 50 g's in each of three axis (X, Y & Z)
Vibration	Continued continuity without degradation to mechanical or physical attributes following vibration. (max acceleration 20 g's at Sine sweep of 10-2000Hz)
Connector Terminal Retention	When subjected to a direct pull, contacts achieve a minimum pull-out force of 25 lbs.
Connector Retention	A mated connector subjected to a pulling force by the exiting wire bundle at 25 lbs. times the number of contacts to a maximum of 100 lbs. applying load for 30 seconds
Thermal Shock	Subjected to 10 cycles at -55°C to +125°C with no cracking, chipping or other damage detrimental to the normal operation of the connector
Insulation Resistance	1000 megohms minimum at 25°C
Mating Cycle Durability	Following 100 cycles of connection engagement and disengagement, degradation either mechanical or electrical is not evident
Contact Millivolt Drop	Size 16 contacts with 16AWG conductor - 100 mV drop max at 13A test current
Water Immersion	IP67-rated in mated condition







A Series™ Family

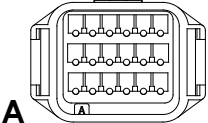

Standard products. Custom solutions
Customer Service +1 800 394 7732

ATV Series™ Heavy Duty Connectors

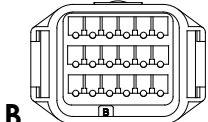
Image	Part Number	Description
	ATV02-18PA	18 Pos., Flange Mount Receptacle, Size 16 Contact, Key A, Grey
	ATV02-18PA-RR01	18 Pos., Flange Mount Receptacle, Size 16 Contact, Key A, Double Reduced Seal, Grey
	ATV02-18PB	18 Pos., Flange Mount Receptacle, Size 16 Contact, Key B, Black
	ATV02-18PB-RR01	18 Pos., Flange Mount Receptacle, Size 16 Contact, Key B, Double Reduced Seal, Black
	ATV02-18PC	18 Pos., Flange Mount Receptacle, Size 16 Contact, Key C, Green
	ATV02-18PC-RR01	18 Pos., Flange Mount Receptacle, Size 16 Contact, Key C, Double Reduced Seal, Green
	ATV02-18PD	18 Pos., Flange Mount Receptacle, Size 16 Contact, Key D, Brown
ATV02-18PD-RR01	18 Pos., Flange Mount Receptacle, Size 16 Contact, Key D, Double Reduced Seal, Brown	
	ATV04-18PA	18 Pos., In-Line Receptacle, Size 16 Contact, Key A, Grey
	ATV04-18PA-RR01	18 Pos., In-Line Receptacle, Size 16 Contact, Key A, Double Reduced Seal, Grey
	ATV04-18PB	18 Pos., In-Line Receptacle, Size 16 Contact, Key B, Black
	ATV04-18PB-RR01	18 Pos., In-Line Receptacle, Size 16 Contact, Key B, Double Reduced Seal, Black
	ATV04-18PC	18 Pos., In-Line Receptacle, Size 16 Contact, Key C, Green
	ATV04-18PC-RR01	18 Pos., In-Line Receptacle, Size 16 Contact, Key C, Double Reduced Seal, Green
	ATV04-18PD	18 Pos., In-Line Receptacle, Size 16 Contact, Key D, Brown
ATV04-18PD-RR01	18 Pos., In-Line Receptacle, Size 16 Contact, Key D, Double Reduced Seal, Brown	
	ATV06-18SA	18 Pos., Plug, Size 16 Contact, Key A, Standard Seal, Grey
	ATV06-18SA-RR01	18 Pos., Plug, Size 16 Contact, Key A, Double Reduced Seal, Grey
	ATV06-18SB	18 Pos., Plug, Size 16 Contact, Key B, Standard Seal, Black
	ATV06-18SB-RR01	18 Pos., Plug, Size 16 Contact, Key B, Double Reduced Seal, Black
	ATV06-18SC	18 Pos., Plug, Size 16 Contact, Key C, Standard Seal, Green
	ATV06-18SC-RR01	18 Pos., Plug, Size 16 Contact, Key C, Double Reduced Seal, Green
	ATV06-18SD	18 Pos., Plug, Size 16 Contact, Key D, Standard Seal, Brown
ATV06-18SD-RR01	18 Pos., Plug, Size 16 Contact, Key D, Double Reduced Seal, Brown	
	AWV-18P	Wedgelock For 18 Pos., ATV Receptacle, Green
	AWV-18S	Wedgelock For 18 Pos., ATV Plug, Green

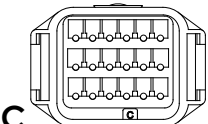
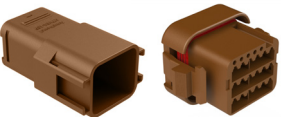
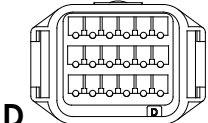
Image	Keying Option A, B, C, D
	
	
	
	

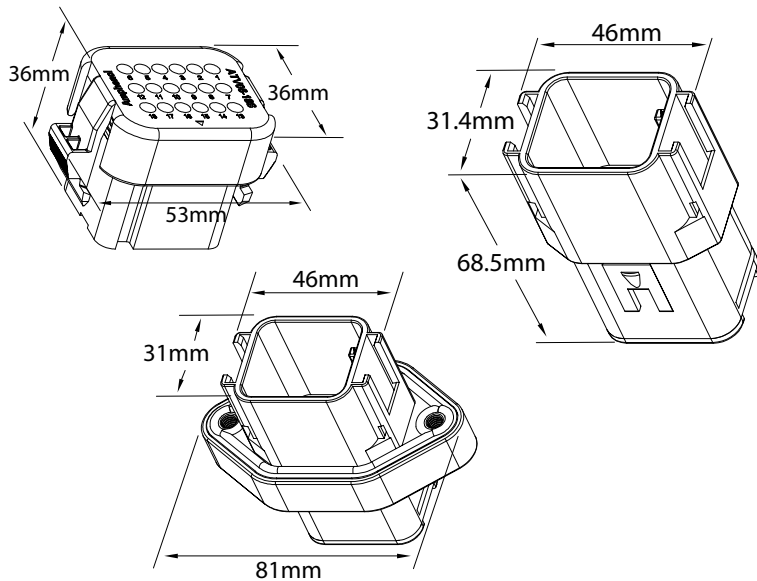

For more information, contact: Customer Service, +1 800 394 7732, csr@amphenol-sine.com