

REVISIONS					
REV	ECO	DESCRIPTION	DATE	BY	APPR
A1	-	RELEASE NEW DRAWING	19JUN18	JONY	TOMMY
A2	-	REVISED DRAWING	10JUL20	JHEAD	DH

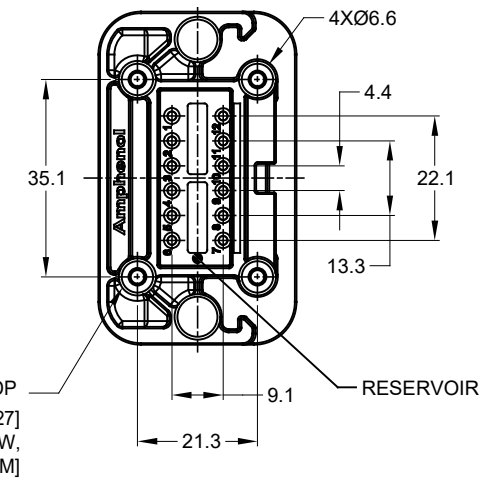

4xØ2.79±0.12 x8.0 DP  
RECOMMENDED SCREW: 4-20 [M3.12 x 1.27]  
THREAD-FORMING SCREW,  
TORQUE:6-10 IN-LB [0.68-1.13 NM]

NOTES: UNLESS OTHERWISE SPECIFIED

- MATERIAL:  
HOUSING: THERMOPLASTIC  
SEAL: SILICONE RUBBER  
CONTACT: COPPER ALLOY
- MODIFICATIONS: FLANGE, PCB MOUNT STRAIGHT
- SPECIFICATIONS:  
3.1 CURRENT RATING: 13 AMPS  
3.2 OPERATING TEMPERATURE: -55°C TO +125°C  
3.3 DIELECTRIC WITHSTANDING VOLTAGE: LESS THAN 2 MILLIAMPS CURRENT LEAKAGE @ 1500 VOLTS AC.  
3.4 INSULATION RESISTANCE: 1000 MEGOHMS MIN @ 25°C.  
3.5 MOISTURE RESISTANCE: IP67 ( MATED CONDITION )  
3.6 MATING CYCLE DURABILITY: 100 CYCLES  
3.7 RoHS COMPLIANT
- MATING PART: AT06-12S\* PLUG (\* = MODIFICATIONS)
- ALL DIMENSIONS ARE FOR REFERENCE USE ONLY.
- POTTED CONNECTORS SPECIFIED FOR UP TO 5 P.S.I. APPLICATIONS.

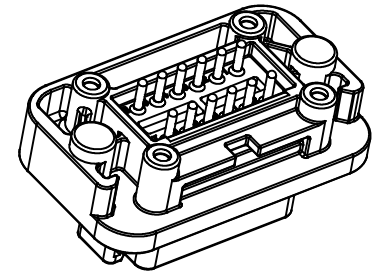
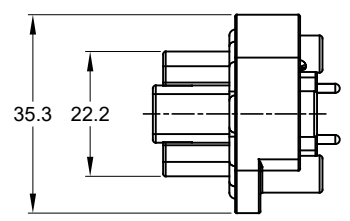

AT15-12PX-BMXX		DESCRIPTION		ITEM
QUANTITY	MATERIALS LIST			
UNLESS OTHERWISE SPECIFIED		SIGNATURES	DATE	<b>Amphenol</b> Sine Systems - www.amphenol-sine.com 44724 Morley Drive Clinton Township, MI 48036
1) All dimensions are in metric (mm).		DRAWN: JONY XIE	19JUN18	
2) Tolerances are as follows:		CHECKED: ORION LI	19JUN18	
1 PL DEC ±0.30 2 PL DEC ±0.15 3 PL DEC ±0.08		ENGINEER:		
3) Note reference =		APPROVAL: TOMMY XIE	19JUN18	<b>BOARDLOCK PCB MOUNT RECEPTACLE,            12 PIN, STRAIGHT, AT SERIES</b>
MATERIAL SPECIFICATIONS:		CUSTOMER:		
PROCESS SPECIFICATIONS:		THIS DRAWING IS SUPPLIED FOR INFORMATION ONLY. DESIGN FEATURES, SPECIFICATIONS AND PERFORMANCE DATA SHOWN HEREON ARE THE PROPERTY OF THE AMPHENOL CORPORATION. NO RIGHTS OF REPRODUCTION ARE IMPLIED. ALL DIMENSIONS ARE SUBJECT TO NORMAL MANUFACTURING VARIATIONS.		
NEXT ASSY:		SIZE: B C-	TYPE: NONE	DWG NO: AT15-12PX-BMXX
		SCALE: NONE		REVISION: A2
		SHEET 1 OF 3		

TITLE: PCB MOUNT RECEPTACLE 12PIN STRAIGHT AT SERIES  
DWG NO: AT15-12PX-BMXX  
REV: A2  
SH: 1  
OF: 3

REVISIONS					
REV	ECO	DESCRIPTION	DATE	BY	APPR
A1	--	RELEASE NEW DRAWING	19JUN18	JONY	TOMMY
A2	--	REVISED DRAWING	10JUL20	JHEAD	DH

P/N AT15-12PA-BMXX  
KEY-A CONFIGURATION  
STANDARD COLOR: GREY

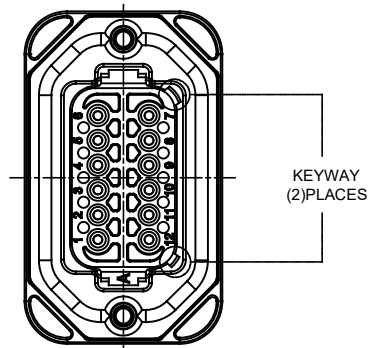

P/N AT15-12PB-BMXX  
KEY-B CONFIGURATION  
STANDARD COLOR: BLACK

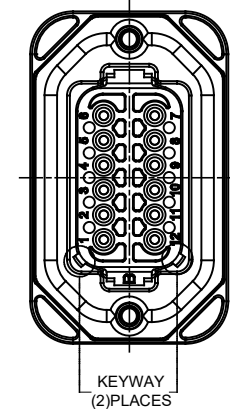

AT15-12PA-BMXX VARIANTS		
CONTACT PLATING	POTTING OR NOT IN RESERVOIR	PART NUMBER
GOLD	NO POTTING	AT15-12PA-BM01
GOLD	POTTING	AT15-12PA-BM02
TIN	NO POTTING	AT15-12PA-BM03
TIN	POTTING	AT15-12PA-BM04

AT15-12PB-BMXX VARIANTS		
CONTACT PLATING	POTTING OR NOT IN RESERVOIR	PART NUMBER
GOLD	NO POTTING	AT15-12PB-BM01
GOLD	POTTING	AT15-12PB-BM02
TIN	NO POTTING	AT15-12PB-BM03
TIN	POTTING	AT15-12PB-BM04

AT15-12PX-BMXX		DESCRIPTION		ITEM
QUANTITY	PART NUMBER			
<b>MATERIALS LIST</b>				
<small>UNLESS OTHERWISE SPECIFIED</small> 1) All dimensions are in metric(mm). 2) Tolerances are as follows: 1 PL DEC ±0.30 2 PL DEC ±0.15 3 PL DEC ±0.08 Fractions ±1/64 Angles ±1° 3) Note reference =		<small>SIGNATURES</small> DRAWN: JONY XIE 19JUN18 CHECKED: ORION LI 19JUN18 ENGINEER: APPROVAL: TOMMY XIE 19JUN18 CUSTOMER:		<b>Amphenol</b> Sine Systems - www.amphenol-sine.com 44724 Morley Drive Clinton Township, MI 48036
<small>MATERIAL SPECIFICATIONS:</small> THIS DRAWING IS SUPPLIED FOR INFORMATION ONLY. DESIGN FEATURES, SPECIFICATIONS AND PERFORMANCE DATA SHOWN HEREON ARE THE PROPERTY OF THE AMPHENOL CORPORATION. NO RIGHTS OF REPRODUCTION ARE IMPLIED. ALL DIMENSIONS ARE SUBJECT TO NORMAL MANUFACTURING VARIATIONS.		<b>BOARDLOCK PCB MOUNT RECEPTACLE, 12 PIN, STRAIGHT, AT SERIES</b>		<small>REVISION</small> A2
<small>PROCESS SPECIFICATIONS:</small> NEXT ASSY:		<small>SIZE</small> <b>B C-</b>	<small>DWG NO.</small> <b>AT15-12PX-BMXX</b>	<small>SCALE</small> NONE
		<small>SHEET</small> 2	<small>OF</small> 3	<small>REV</small> A2

TITLE: PCB MOUNT RECEPTACLE, 12PIN, STRAIGHT, AT SERIES  
 DWG NO.: AT15-12PX-BMXX  
 REV: A2  
 SH: 2  
 OF: 3

REVISIONS					
REV	ECO	DESCRIPTION	DATE	BY	APPR
01	--	RELEASE NEW DRAWING	19JUN18	JONY	TOMMY
A2	--	REVISED DRAWING	10JUL20	JHEAD	DH

P/N AT15-12PC-BMXX  
KEY-C CONFIGURATION  
STANDARD COLOR: GREEN

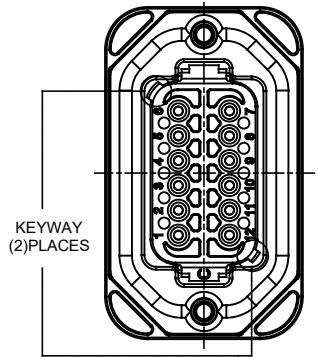

KEYWAY  
(2)PLACES

P/N AT15-12PD-BMXX  
KEY-D CONFIGURATION  
STANDARD COLOR: BROWN

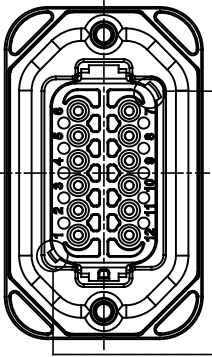

KEYWAY  
(2)PLACES

AT15-12PC-BMXX VARIANTS		
CONTACT PLATING	POTTING OR NOT IN RESERVOIR	PART NUMBER
GOLD	NO POTTING	AT15-12PC-BM01
GOLD	POTTING	AT15-12PC-BM02
TIN	NO POTTING	AT15-12PC-BM03
TIN	POTTING	AT15-12PC-BM04

AT15-12PD-BMXX VARIANTS		
CONTACT PLATING	POTTING OR NOT IN RESERVOIR	PART NUMBER
GOLD	NO POTTING	AT15-12PD-BM01
GOLD	POTTING	AT15-12PD-BM02
TIN	NO POTTING	AT15-12PD-BM03
TIN	POTTING	AT15-12PD-BM04

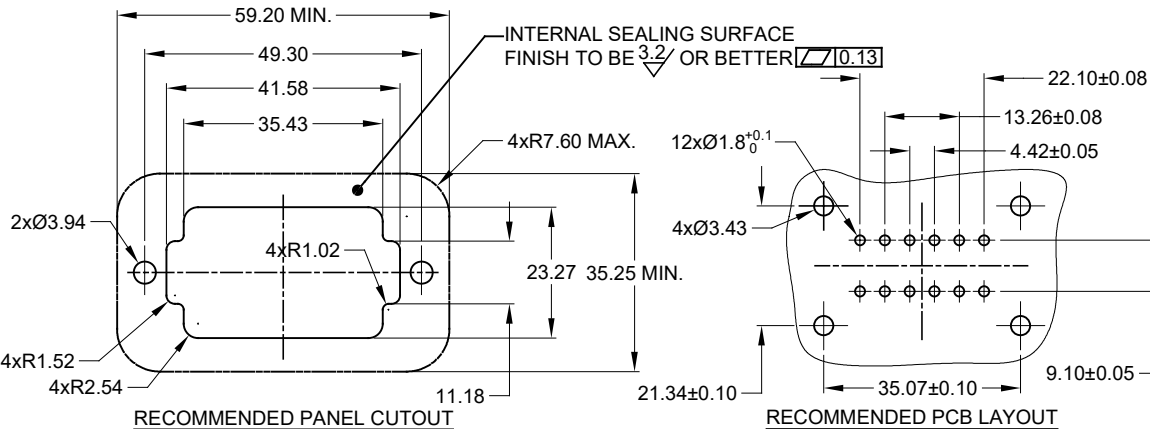

RECOMMENDED PANEL CUTOUT

RECOMMENDED PCB LAYOUT

AT15-12PX-BMXX		DESCRIPTION	
QUANTITY	PART NUMBER	ITEM	
<b>MATERIALS LIST</b>			
UNLESS OTHERWISE SPECIFIED 1) All dimensions are in metric (mm). 2) Tolerances are as follows: 1 PL DEC ±0.30   Fractions ±1/64 2 PL DEC ±0.15   Angles ±1° 3 PL DEC ±0.08 3) Note reference =		SIGNATURES	DATE
		DRAWN: JONY XIE	19JUN18
		CHECKED: ORION LI	19JUN18
		ENGINEER:	
		APPROVAL: TOMMY XIE	19JUN18
MATERIAL SPECIFICATIONS:		CUSTOMER:	
PROCESS SPECIFICATIONS:		THIS DRAWING IS SUPPLIED FOR INFORMATION ONLY. DESIGN FEATURES, SPECIFICATIONS AND PERFORMANCE DATA SHOWN HEREON ARE THE PROPERTY OF THE AMPHENOL CORPORATION. NO RIGHTS OF REPRODUCTION ARE IMPLIED. ALL DIMENSIONS ARE SUBJECT TO NORMAL MANUFACTURING VARIATIONS.	
NEXT ASSY:		SCALE: NONE	
		SIZE: C-	REVISION: A2
		DWG NO: AT15-12PX-BMXX	
		SHEET 3 OF 3	

TITLE: PCB MOUNT RECEPTACLE, P/N STRAIGHT, AT SERIES  
DWG NO: AT15-12PX-BMXX  
REV: A2  
SH: 3  
OF: 3