

REVISIONS					
REV	ECO	DESCRIPTION	DATE	BY	APPR
A3		RELEASE NEW DWG FORMAT	24/JUL/13	DRP	

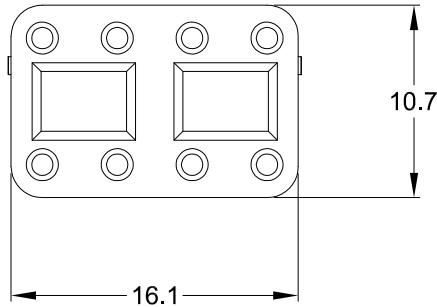
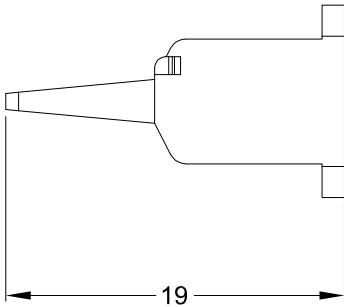
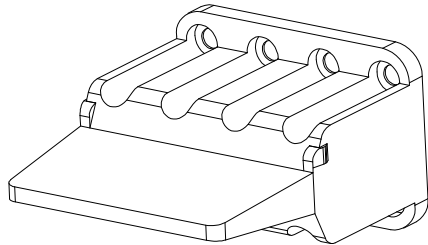
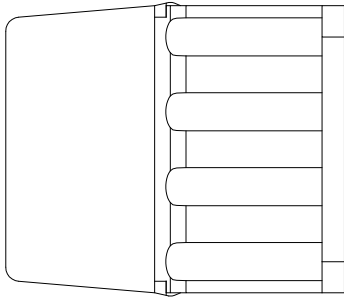

NOTES: UNLESS OTHERWISE SPECIFIED

1. MATERIAL: THERMOPLASTIC; COLOR: ORANGE
2. RoHS COMPLIANT
3. CAVITIES: 8
4. KEYED: N/A
5. USE WITH CONNECTORS: ATM06-08S\*  
(\* = MODIFICATIONS AND COLORS)
6. ALL DIMENSIONS ARE FOR REFERENCE USE ONLY.

AWM-8S		DESCRIPTION		ITEM
QUANTITY	PART NUMBER	MATERIALS LIST		
UNLESS OTHERWISE SPECIFIED		SIGNATURES		DATE
1) All dimensions are in metric (mm).		DRAWN: D.PARKS		24/JUL/13
2) Tolerances are as follows:		CHECKED:		
1 PL DEC ±0.30		ENGINEER:		
2 PL DEC ±0.15		APPROVAL:		
3 PL DEC ±0.08		CUSTOMER:		
3) Note reference =		THIS DRAWING IS SUPPLIED FOR INFORMATION ONLY. DESIGN FEATURES, SPECIFICATIONS AND PERFORMANCE DATA SHOWN HEREON ARE THE PROPERTY OF THE AMPHENOL CORPORATION. NO RIGHTS OF REPRODUCTION ARE IMPLIED. ALL DIMENSIONS ARE SUBJECT TO NORMAL MANUFACTURING VARIATIONS.		
MATERIAL SPECIFICATIONS:		SINE SYSTEMS - www.amphenol-sine.com		
PROCESS SPECIFICATIONS:		44724 Morley Drive		
NEXT ASSY:		Clinton Township, MI 48036		
		S-WEDGELOCK, 8 POSITION, ATM SERIES		
SIZE	TYPE	DWG NO:	REVISION	
A	C-	AWM-8S	A3	
SCALE: NONE		SHEET 1 OF 1		