

REVISIONS					
REV	ECO	DESCRIPTION	DATE	BY	APPR
A1	-	RELEASED DRAWING	04JAN21	LOUIE	TOMMY
A2	-	UPDATE DRAWING	10MAY21	SULLEN	TOMMY

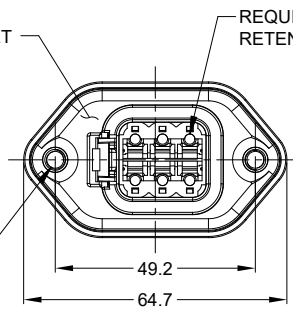
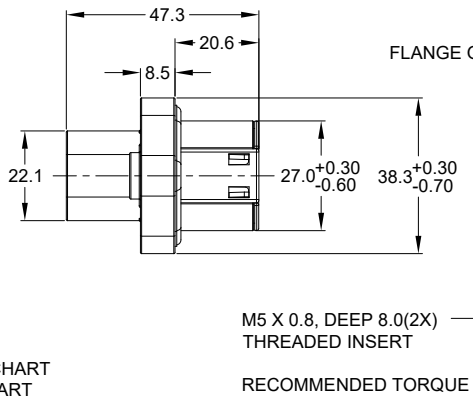
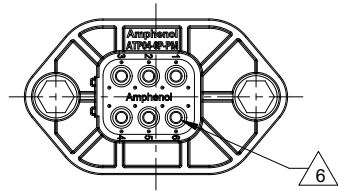
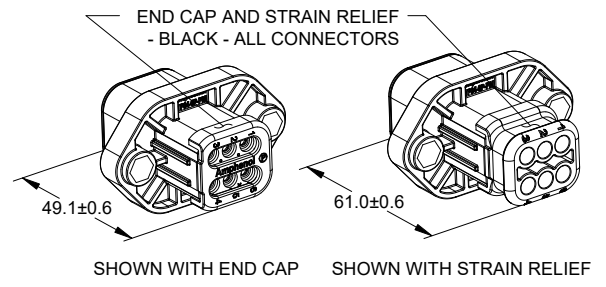
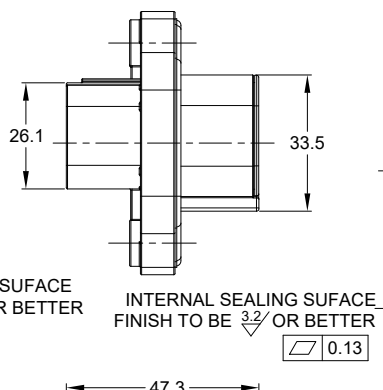
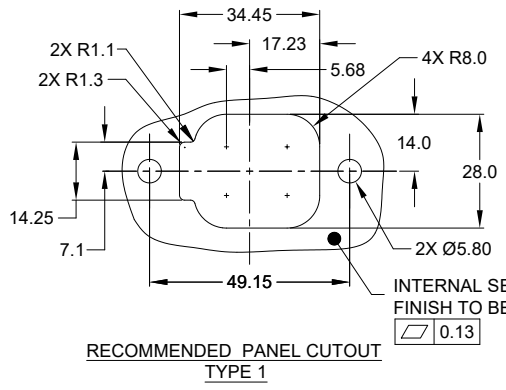

PART NUMBER CHART		
PART NUMBER	HOUSING AND INSERT COLOR	STRAIN RELIEF AND END CAP COLOR
ATP04-6P-PM0x	GREY	BLACK
ATP04-6P-PM0xBK	BLACK	BLACK

MODIFICATIONS				
PART NUMBER	SEAL	END CAP	STRAIN RELIEF	WEIGHT (GRAMS)
ATP04-6P-PM05XX	STANDARD	NO	NO	37.2
ATP04-6P-PM06XX	REDUCED DIA.	NO	NO	37.2
ATP04-6P-PM05ECXX	STANDARD	YES	NO	39.6
ATP04-6P-PM06ECXX	REDUCED DIA.	YES	NO	39.6
ATP04-6P-PM05SRXX	STANDARD	NO	YES	45.8
ATP04-6P-PM06SRXX	REDUCED DIA.	NO	YES	45.8

NOTES: UNLESS OTHERWISE SPECIFIED

- MATERIAL:**
 HOUSING: THERMOPLASTIC; COLOR: SEE PART NUMBER CHART
 INSERT: THERMOPLASTIC; COLOR: SEE PART NUMBER CHART
 END CAP: THERMOPLASTIC; COLOR: BLACK
 STRAIN RELIEF: THERMOPLASTIC; COLOR: BLACK
 SEAL: SILICONE RUBBER; COLOR: RED FOR STANDARD, YELLOW FOR REDUCED DIA.
 FLANGE GASKET: SILICONE RUBBER; COLOR: RED
- MODIFICATIONS:** FLANGE, END CAP (OPT), REDUCED DIAMETER WIRE SEAL (OPT), STRAIN RELIEF (OPT)
- SPECIFICATIONS:**
 - CURRENT RATING: 25 AMPS
 - OPERATING TEMPERATURE: -55°C TO +125°C
 - DIELECTRIC WITHSTANDING VOLTAGE: LESS THAN 2 MILLIAMPS CURRENT LEAKAGE @ 1500 VOLTS AC.
 - INSULATION RESISTANCE: 1000 MEGOHMS MIN @ 25°C.
 - MOISTURE RESISTANCE: IP68 (1M OF WATER FOR A PERIOD OF 24 HOURS, MATED CONDITION)
 - MATING CYCLE DURABILITY: 100 CYCLES
 - RoHS COMPLIANT
- MATING PART:** ATP06-6S* PLUG.
 (* = MODIFICATIONS AND COLORS)

5. ALL DIMENSIONS ARE FOR REFERENCE USE ONLY.

⚠ CONTACT SIZE AND REAR SEAL WIRE RANGE:

STANDARD SEAL:

CONTACT SIZE	MIN. INSUL O.D.	MAX. INSUL O.D.	TYPICAL WIRE RANGE
12	3.40 mm (.134 in)	4.95 mm (.195 in)	10 - 14 AWG (5.0-2.0mm ²)

REDUCED DIAMETER SEAL:

CONTACT SIZE	MIN. INSUL O.D.	MAX. INSUL O.D.	TYPICAL WIRE RANGE
12	2.46 mm (.097 in)	4.01 mm (.158 in)	12 - 14 AWG (3.0-2.0mm ²)

ATP04-6P-PM0xXX		DESCRIPTION		ITEM
QUANTITY	PART NUMBER	MATERIALS LIST		
UNLESS OTHERWISE SPECIFIED 1) All dimensions are in metric (mm). 2) Tolerances are as follows: 1 PL DEC ±0.30 2 PL DEC ±0.15 3 PL DEC ±0.08 Fractions ±1/64 Angles ±1°		SIGNATURES		DATE
DRAWN: SULLEN.ZHANG		ORION.LI		10MAY21
CHECKED: ORION.LI		TOMMY.XIE		11MAY21
ENGINEER:		APPROVAL:		12MAY21
MATERIAL SPECIFICATIONS:		CUSTOMER:		
PROCESS SPECIFICATIONS:		THIS DRAWING IS SUPPLIED FOR INFORMATION ONLY. DESIGN FEATURES, SPECIFICATIONS AND PERFORMANCE DATA SHOWN HEREON ARE THE PROPERTY OF THE AMPHENOL CORPORATION. NO RIGHTS OF REPRODUCTION ARE IMPLIED. ALL DIMENSIONS ARE SUBJECT TO NORMAL MANUFACTURING VARIATIONS.		
NEXT ASSY:		SCALE: NONE	SIZE: B C-	TYPE: ATP04-6P-PM0xXX
		REVISION: A2	SHEET 1 OF 1	

Amphenol

Sine Systems - www.amphenol-sine.com
 44724 Morley Drive
 Clinton Township, MI 48036





6 POS, RECEPTACLE, PIN, ATP SERIES, W/ FLANGE, GASKET, THREADED INSERT



TITLE: 6POS RECEPTACLE, PIN, ATP SERIES, W/ FLANGE, GASKET, THREADED INSERT
 DWG NO: ATP04-6P-PM0xXX
 REV: A2
 SH: 1
 OF: 1

ATP Series™ - Contact Size 12 Options



Machined Contacts, Sockets & Pins				
Part Number	Description	Size	AWG	Type
AT60-204-12141-10	Male Contact - Pin, Nickel-plated	12	10-12	Machined
AT62-203-12141-10	Female Contact - Socket, Nickel-plated	12	10-12	Machined
AT60-220-1231	Male Contact - Pin, Gold-plated	12	12-14	Machined
AT62-210-1231	Female Contact - Socket, Gold-plated	12	12-14	Machined
AT60-204-12141	Male Contact - Pin, Nickel-plated	12	12-14	Machined
AT62-203-12141	Female Contact - Socket, Nickel-plated	12	12-14	Machined

DiagnosticGrade™ Machined Contacts, Sockets & Pins				
• Smaller AWG for Diagnostic Applications • Gold-plated • Increased Mating Cycles • Cost-effective				
Part Number	Description	Size	AWG	Type
65-54749	Male Contact - DiagnosticGrade™, Pin, Gold-plated	12	20	Machined
AT62-210-1231-1820	Female Contact - DiagnosticGrade™, Socket, Gold-plated	12	20	Machined

Tooling - Machined Contacts		
Part	Part Number	Description
	CA-5D12	Universal Hand Crimp Tool, Size 12/16/20 (Machined contacts only)
	CA-5E12	Pneumatic Crimp Tool, Size 12/16/20 (Machined contacts only)
	M300-25A	Hand Crimp Tool used with Crimp Locator MFX-3966, Size 12, 10AWG (Machined contacts only)
	MFX-3966	Contact Locator used with Hand Crimp Tool M300-25A, Size 12, 10AWG (Machined contacts only)

Contact Removal Tools		
Part	Part Number	Description
	ATRT-100	Used for removal of contacts for A Series™ products
	AT11-337-1205	Contact Removal Tool, Plastic, Size 12
	A114017	Sealing Plug, Size 12, White

Stamped & Formed Contacts, Sockets & Pins				
Part Number	Description	Size	AWG	Type
AT60-12-0244	Male Contact - Pin, Gold-plated	12	10-12	Stamped & Formed
AT62-12-0244	Female Contact - Socket, Gold-plated	12	10-12	Stamped & Formed
AT60-12-0222	Male Contact - Pin, Nickel-plated	12	10-12	Stamped & Formed
AT62-12-0222	Female Contact - Socket, Nickel-plated	12	10-12	Stamped & Formed
AT60-12-0144	Male Contact - Pin, Gold-plated	12	12-14	Stamped & Formed
AT62-12-0144	Female Contact - Socket, Gold-plated	12	12-14	Stamped & Formed
AT60-12-0166	Male Contact - Pin, Nickel-plated	12	12-14	Stamped & Formed
AT62-12-0166	Female Contact - Socket, Nickel-plated	12	12-14	Stamped & Formed

Tooling - Stamped & Formed Contacts		
Part	Part Number	Description
	MFX-3973	Crimp Die - Size 12 (S&F contacts only)
	MFX-3985	Crimp Die - Size 12 (S&F contacts only) 10-12AWG -02XX Series
	ATT-12-00	Hand Crimp Tool - Size 12, 12AWG (S&F contacts only)
	ATT-12-01	Hand Crimp Tool - Size 12, 10AWG (S&F contacts only)