

REVISIONS

REV	ECO	DESCRIPTION	DATE	BY	APPR
A1	--	RELEASE DRAWING	05/DEC/19	SULLEN	TOMMY

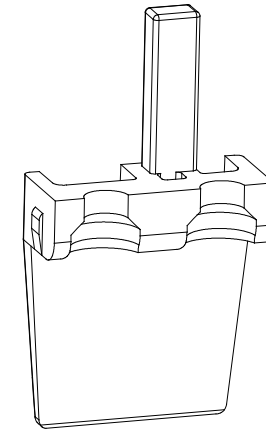
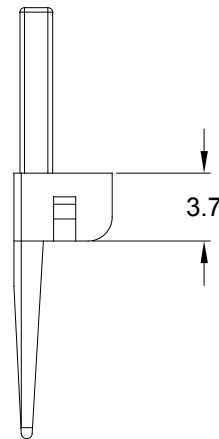
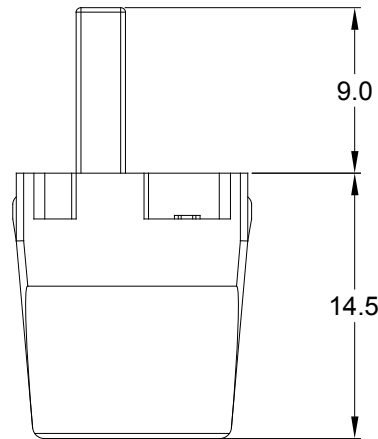
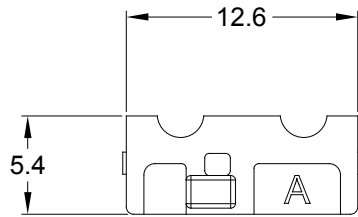

NOTES: UNLESS OTHERWISE SPECIFIED

1. MATERIAL: THERMOPLASTIC; COLOR: SEE SHEET 2
2. RoHS COMPLIANT
3. CAVITIES: 2
4. KEYED: SEE SHEET 2
5. USE WITH CONNECTORS ATP04-2P*
(* = MODIFICATIONS AND COLORS)
6. ALL DIMENSIONS ARE FOR REFERENCE USE ONLY.

QUANTITY	SEE SHEET 2	DESCRIPTION	ITEM												
MATERIALS LIST															
<p>UNLESS OTHERWISE SPECIFIED</p> <p>1) All dimensions are in metric(mm).</p> <p>2) Tolerances are as follows: 1 PL DEC ±0.30 Fractions ±1/64 2 PL DEC ±0.15 Angles ±1° 3 PL DEC ±0.08</p> <p>3) Note reference = </p>		<table border="1"> <thead> <tr> <th>SIGNATURES</th> <th>DATE</th> </tr> </thead> <tbody> <tr> <td>DRAWN: SULLEN.ZHANG</td> <td>05/DEC/19</td> </tr> <tr> <td>CHECKED: ORION.LI</td> <td>05/DEC/19</td> </tr> <tr> <td>ENGINEER:</td> <td></td> </tr> <tr> <td>APPROVAL: TOMMY.XIE</td> <td>05/DEC/19</td> </tr> <tr> <td>CUSTOMER:</td> <td></td> </tr> </tbody> </table>		SIGNATURES	DATE	DRAWN: SULLEN.ZHANG	05/DEC/19	CHECKED: ORION.LI	05/DEC/19	ENGINEER:		APPROVAL: TOMMY.XIE	05/DEC/19	CUSTOMER:	
SIGNATURES	DATE														
DRAWN: SULLEN.ZHANG	05/DEC/19														
CHECKED: ORION.LI	05/DEC/19														
ENGINEER:															
APPROVAL: TOMMY.XIE	05/DEC/19														
CUSTOMER:															
MATERIAL SPECIFICATIONS:		<p>Amphenol</p> <p>Sine Systems - www.amphenol-sine.com 44724 Morley Drive Clinton Township, MI 48036</p> <p>P-WEDGELOCK,2 POS,ATP SERIES</p>													
PROCESS SPECIFICATIONS:															
NEXT ASSY:		<table border="1"> <tr> <td>SIZE</td> <td>TYPE</td> <td>DWG NO:</td> <td>REVISION</td> </tr> <tr> <td>A</td> <td>C-</td> <td>AWP-2PX</td> <td>A1</td> </tr> <tr> <td colspan="2">SCALE: NONE</td> <td colspan="2">SHEET 1 OF 2</td> </tr> </table>		SIZE	TYPE	DWG NO:	REVISION	A	C-	AWP-2PX	A1	SCALE: NONE		SHEET 1 OF 2	
SIZE	TYPE	DWG NO:	REVISION												
A	C-	AWP-2PX	A1												
SCALE: NONE		SHEET 1 OF 2													

REVISIONS

REV	ECO	DESCRIPTION	DATE	BY	APPR
A1	--	RELEASE DRAWING	05/DEC/19	SULLEN	TOMMY

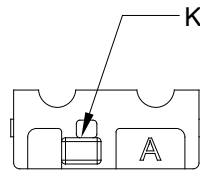

KEYED A

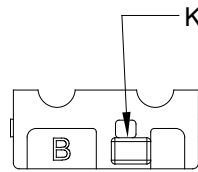

KEYED B

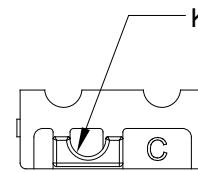

KEYED C

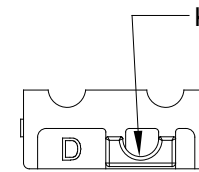

KEYED D

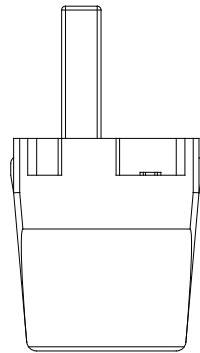

AWP-2PA
GRAY

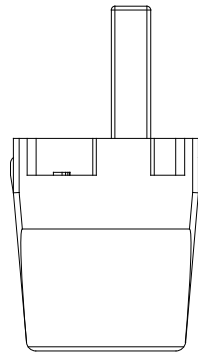

AWP-2PB
BLACK

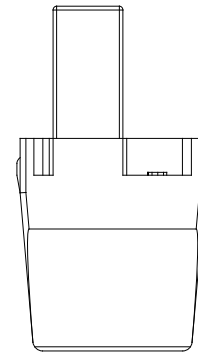

AWP-2PC
GREEN

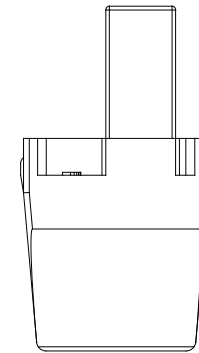

AWP-2PD
BROWN

AWP-2PX			
QUANTITY	PART NUMBER	DESCRIPTION	ITEM

MATERIALS LIST

UNLESS OTHERWISE SPECIFIED

- 1) All dimensions are in metric(mm).
- 2) Tolerances are as follows:
 1 PL DEC ±0.30 Fractions ±1/64
 2 PL DEC ±0.15 Angles ±1°
 3 PL DEC ±0.08

3) Note reference =

MATERIAL SPECIFICATIONS:

PROCESS SPECIFICATIONS:

NEXT ASSY:

SIGNATURES	DATE
DRAWN: SULLEN.ZHANG	05/DEC/19
CHECKED: ORION.LI	05/DEC/19
ENGINEER:	
APPROVAL: TOMMY.XIE	05/DEC/19
CUSTOMER:	

THIS DRAWING IS SUPPLIED FOR INFORMATION ONLY. DESIGN FEATURES, SPECIFICATIONS AND PERFORMANCE DATA SHOWN HEREON ARE THE PROPERTY OF THE AMPHENOL CORPORATION. NO RIGHTS OF REPRODUCTION ARE IMPLIED. ALL DIMENSIONS ARE SUBJECT TO NORMAL MANUFACTURING VARIATIONS.

Amphenol

Sine Systems - www.amphenol-sine.com
 44724 Morley Drive
 Clinton Township, MI 48036

P-WEDGELOCK,2 POS,ATP SERIES

SIZE	TYPE	DWG NO:	REVISION
A	C-	AWP-2PX	A1
SCALE: NONE		SHEET 2 OF 2	