

REVISIONS					
REV	ECO	DESCRIPTION	DATE	BY	APPR
A1	-	RELEASE NEW DRAWING	13NOV20	IAN	TOMMY

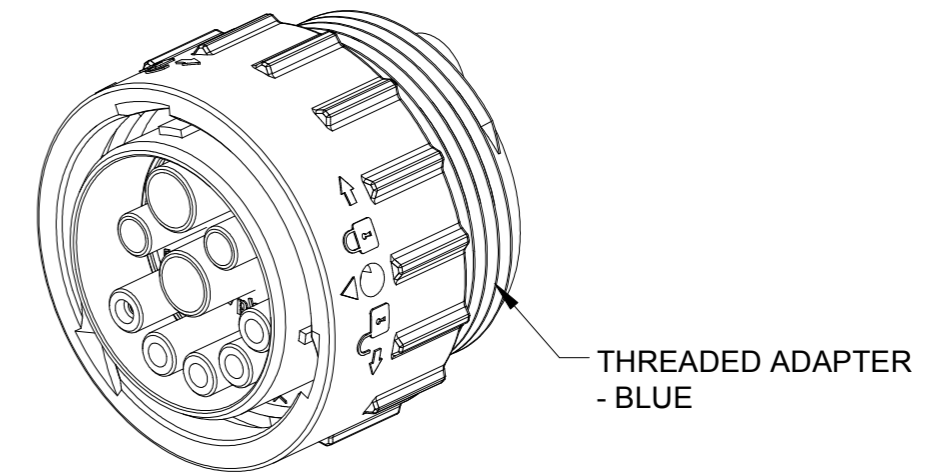
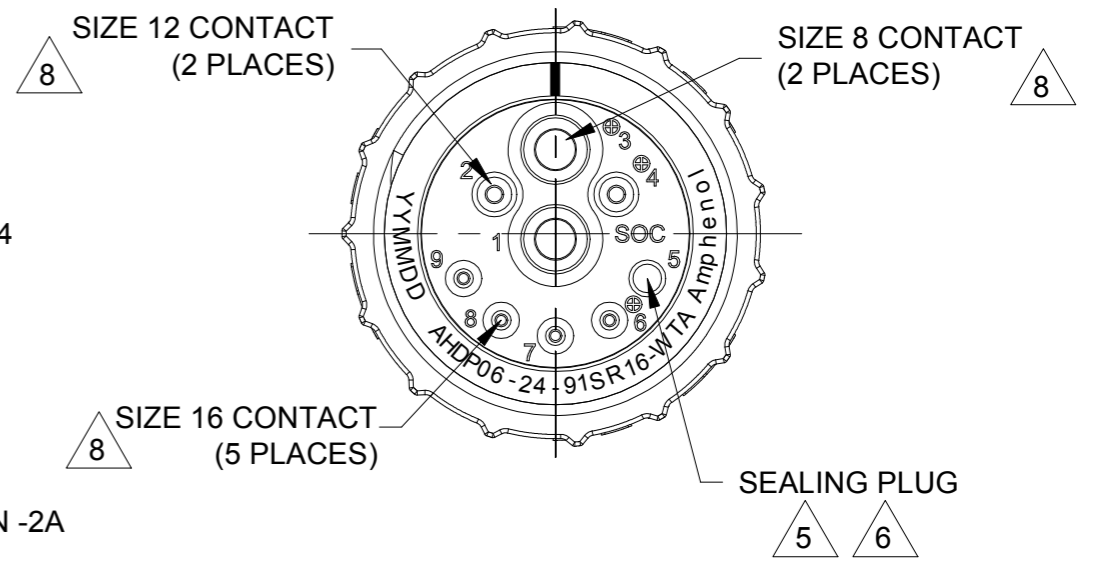

NOTES: UNLESS OTHERWISE SPECIFIED

- MATERIAL:  
HOUSING: THERMOPLASTIC; BLACK  
SEAL: SILICONE RUBBER
- MODIFICATIONS: THREADED ADAPTER;  
REDUCED DIA. WIRE SEAL FOR SIZE 12 & SIZE 16;

3. SPECIFICATIONS:

- OPERATING TEMPERATURE: -55°C TO +125°C.
- DIELECTRIC WITHSTANDING VOLTAGE: LESS THAN 2 MILLIAMPS CURRENT LEAKAGE @ 1500 VOLTS AC.
- INSULATION RESISTANCE: 1000 MEGOHM MIN @ 25°C.
- MOISTURE RESISTANCE: IP67 & IP69K ( MATED CONDITION ).
- MATING CYCLE DURABILITY: 100 CYCLES
- RoHS COMPLIANT

4. MATING PART: AHDP04-24-91P\* -XXX (\* = SEAL TYPE ,XXX = ALL MODIFICATIONS).

5. CONTACTS 4 AND 5 ARE INTERNALLY CONNECTED.(BUILT-IN BRIDGE).

6. CAVITY 5 IS WITH CONTACT SIZE 16 AND THE GROMMET IS SEAL.

7. ALL DIMENSIONS ARE FOR REFERENCE USE ONLY.

8. CONTACT SIZE AND WIRE RANGE:



CONTACT SIZE	MIN. INSUL O.D.	MAX. INSUL O.D.	TYPICAL WIRE RANGE	CURRENT RATING
8	6.50mm (.256in)	7.42mm (.292in)	6AWG (16.0-13.0mm <sup>2</sup> )	60AMPS
12	2.46mm (.097in)	4.01mm (.158in)	10-14AWG (6.0-2.0mm <sup>2</sup> )	25AMPS
16	1.35mm (.053in)	3.05mm (.120in)	14-20AWG (2.0-0.5mm <sup>2</sup> )	13AMPS



AHDP06-24-91SR16-WTA		DESCRIPTION		ITEM
QUANTITY	PART NUMBER	MATERIALS LIST		
UNLESS OTHERWISE SPECIFIED				
1) All dimensions are in metric(mm).				
2) Tolerances are as follows:				
1 PL DEC ±0.30 Fractions ±1/64				
2 PL DEC ±0.15 Angles ±1°				
3 PL DEC ±0.08				
3) Note reference = X				
SIGNATURES		DATE		
DRAWN: IAN.XIAO		13NOV20		
CHECKED: ORION.LI		16NOV20		
ENGINEER:				
APPROVAL: TOMMY.XIE		17NOV20		
MATERIAL SPECIFICATIONS:		CUSTOMER:		
PROCESS SPECIFICATIONS:		THIS DRAWING IS SUPPLIED FOR INFORMATION ONLY. DESIGN FEATURES, SPECIFICATIONS AND PERFORMANCE DATA SHOWN HEREON ARE THE PROPERTY OF THE AMPHENOL CORPORATION. NO RIGHTS OF REPRODUCTION ARE IMPLIED. ALL DIMENSIONS ARE SUBJECT TO NORMAL MANUFACTURING VARIATIONS.		
NEXT ASSY:		SCALE: NONE		
		SIZE B C- AHDP06-24-91SR16-WTA		REVISION A1
		SHEET 1		OF 1

TITLE: 09POS,PLUG,SOCKET,24SZ,RD SEAL,WTA,DURAMATE AHDP  
DWG NO: AHDP06-24-91SR16-WTA  
REV: A1  
SH: 1  
OF: 1



# AT Series™ - Contact Size 16 Options

Machined Contacts, Sockets & Pins				
Part Number	Description	Size	AWG	Type
AT60-215-1631	Male Contact - Pin, Gold-plated	16	14	Machined
AT62-209-1631	Female Contact - Socket, Gold-plated	16	14	Machined
AT60-215-16141	Male Contact - Pin, Nickel-plated	16	14	Machined
AT62-209-16141	Female Contact - Socket, Nickel-plated	16	14	Machined
AT60-202-1631	Male Contact - Pin, Gold-plated	16	16-20	Machined
AT62-201-1631	Female Contact - Socket, Gold-plated	16	16-20	Machined
AT60-202-16141	Male Contact - Pin, Nickel-plated	16	16-20	Machined
AT62-201-16141	Female Contact - Socket, Nickel-plated	16	16-20	Machined
AT60-202-1631-22	Male Contact - Pin, Gold-plated	16	22-24	Machined
AT62-201-1631-22	Female Contact - Socket, Gold-plated	16	22-24	Machined
AT60-202-16141-22	Male Contact - Pin, Nickel-plated	16	22-24	Machined
AT62-201-16141-22	Female Contact - Socket, Nickel-plated	16	22-24	Machined

Tooling - Machined Contacts		
Part	Part Number	Description
	CA-5D12	Universal Hand Crimp Tool, Size 12/16/20 (Machined contacts only)
	CA-5E12	Pneumatic Crimp Tool, Size 12/16/20 (Machined contacts only)

Contact Removal Tools		
Part	Part Number	Description
	ATRT-100	Used for removal of contacts for A Series™ products
	AT11-310-1605	Contact Removal Tool, Plastic, Size 16
	A114017	Sealing Plug, Size 16, White

Stamped & Formed Contacts, Sockets & Pins				
Part Number	Description	Size	AWG	Type
AT60-14-0144	Male Contact - Pin, Gold-plated	16	14-16	Stamped & Formed
AT62-14-0144	Female Contact - Socket, Gold-plated	16	14-16	Stamped & Formed
AT60-14-0122	Male Contact - Pin, Nickel-plated	16	14-16	Stamped & Formed
AT62-14-0122	Female Contact - Socket, Nickel-plated	16	14-16	Stamped & Formed
AT60-16-0144	Male Contact - Pin, Gold-plated	16	16-18	Stamped & Formed
AT62-16-0144	Female Contact - Socket, Gold-plated	16	16-18	Stamped & Formed
AT60-16-0122	Male Contact - Pin, Nickel-plated	16	16-18	Stamped & Formed
AT62-16-0122	Female Contact - Socket, Nickel-plated	16	16-18	Stamped & Formed
AT60-16-0644	Male Contact - Pin, Gold-plated	16	18-20	Stamped & Formed
AT62-16-0644	Female Contact - Socket, Gold-plated	16	18-20	Stamped & Formed
AT60-16-0622	Male Contact - Pin, Nickel-plated	16	18-20	Stamped & Formed
AT62-16-0622	Female Contact - Socket, Nickel-plated	16	18-20	Stamped & Formed
AT60-16-0844	Male Contact - Pin, Gold-plated	16	20-22	Stamped & Formed
AT62-16-0844	Female Contact - Socket, Gold-plated	16	20-22	Stamped & Formed
AT60-16-0822	Male Contact - Pin, Nickel-plated	16	20-22	Stamped & Formed
AT62-16-0822	Female Contact - Socket, Nickel-plated	16	20-22	Stamped & Formed



Tooling - Stamped & Formed Contacts		
Part	Part Number	Description
	MFX-3950	Crimp Die - Size 16, 18-20AWG (S&F contacts only)
	MFX-3953	Crimp Die - Size 16, 16-18AWG (S&F contacts only)
	MFX-3975	Crimp Die - Size 16, 14-16AWG (S&F contacts only)
	MFX-3990	Crimp Die - Size 16, 20-22AWG (S&F contacts only)
	ATT-16-00	Hand Crimp Tool - Size 16, 14-16AWG (S&F contacts only)
	ATT-16-01	Hand Crimp Tool - Size 16, 18-20AWG (S&F contacts only)
	ATT-1612-03	Hand Crimp Tool - Size 16, 20-22AWG (S&F contacts only)



**Amphenol Sine Systems**  
 44724 Morley Drive  
 Clinton Township, MI 48036 USA  
[www.amphenol-sine.com](http://www.amphenol-sine.com)  
 09/2021

# MagnaMate™ ATHP - DuraMate™ AHDP - DuraMate™ AHDM Series - Contact Size 12 Options



Machined Contacts, Sockets & Pins				
Part Number	Description	Size	AWG	Type
AT60-204-12141-10	Male Contact - Pin, Nickel-plated	12	10-12	Machined
AT62-203-12141-10	Female Contact - Socket, Nickel-plated	12	10-12	Machined
AT60-220-1231	Male Contact - Pin, Gold-plated	12	12-14	Machined
AT62-210-1231	Female Contact - Socket, Gold-plated	12	12-14	Machined
AT60-204-12141	Male Contact - Pin, Nickel-plated	12	12-14	Machined
AT62-203-12141	Female Contact - Socket, Nickel-plated	12	12-14	Machined

DiagnosticGrade™ Machined Contacts, Sockets & Pins				
• Smaller AWG for Diagnostic Applications • Gold-plated • Increased Mating Cycles • Cost-effective				
Part Number	Description	Size	AWG	Type
65-54749	Male Contact - DiagnosticGrade™, Pin, Gold-plated	12	20	Machined
AT62-210-1231-1820	Female Contact - DiagnosticGrade™, Socket, Gold-plated	12	20	Machined

Tooling - Machined Contacts		
Part	Part Number	Description
	CA-5D12	Universal Hand Crimp Tool, Size 12/16/20 (Machined contacts only)
	CA-5E12	Pneumatic Crimp Tool, Size 12/16/20 (Machined contacts only)

Contact Removal Tools		
Part	Part Number	Description
	AT11-337-1205	Contact Removal Tool, Plastic, Size 12
	A114017	Sealing Plug, Size 12, White



Stamped & Formed Contacts, Sockets & Pins				
Part Number	Description	Size	AWG	Type
AT60-12-0244	Male Contact - Pin, Gold-plated	12	10-12	Stamped & Formed
AT62-12-0244	Female Contact - Socket, Gold-plated	12	10-12	Stamped & Formed
AT60-12-0222	Male Contact - Pin, Nickel-plated	12	10-12	Stamped & Formed
AT62-12-0222	Female Contact - Socket, Nickel-plated	12	10-12	Stamped & Formed
AT60-12-0144	Male Contact - Pin, Gold-plated	12	12-14	Stamped & Formed
AT62-12-0144	Female Contact - Socket, Gold-plated	12	12-14	Stamped & Formed
AT60-12-0166	Male Contact - Pin, Nickel-plated	12	12-14	Stamped & Formed
AT62-12-0166	Female Contact - Socket, Nickel-plated	12	12-14	Stamped & Formed

Tooling - Stamped & Formed Contacts		
Part	Part Number	Description
	MFX-3973	Crimp Die - Size 12 (S&F contacts only)
	MFX-3985	Crimp Die - Size 12 (S&F contacts only) 10-12AWG -02XX Series
	ATT-12-00	Hand Crimp Tool - Size 12, 12AWG (S&F contacts only)
	ATT-12-01	Hand Crimp Tool - Size 12, 10AWG (S&F contacts only)

**Amphenol Sine Systems**  
 44724 Morley Drive  
 Clinton Township, MI 48036 USA  
[www.amphenol-sine.com](http://www.amphenol-sine.com)  
 01/2022

## DuraMate™ ATHD Series™ - Contact Size 8 Options

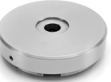
Machined Contacts, Pins and Sockets					
Part Number	Description	Size	AWG	Type	Amps
AT60-204-08141	Male Contact - Pin, Copper Alloy, Nickel-Plated	8	8-10	Machined	60A
AT62-203-08141	Female Contact - Socket, Copper Alloy, Nickel-Plated	8	8-10	Machined	60A

Tooling - Machined Contacts		
Part	Part Number	Description
	WA23	Heavy Duty Pneumatic Crimp Tool -Uses Universal Positioner Part No. WA23-101DA and Crimp Locator MFX-3961
	WA23-2	Die Assembly -for CA-5E12 Heavy Duty Pneumatic Crimp Tool, Size 8
	WA23-10	Contact Locator, Size 8
	96-978-22	Crimper and Dies -for Size 10mm <sup>2</sup> -185mm <sup>2</sup> Wires

Contact Removal Tools		
Part	Part Number	Description
	AT114008	Contact Removal Tool, Plastic, Size 8, 8-10AWG