

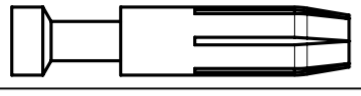













Teilenummer part number	Anschluss- querschnitt terminal cross-section	AWG AWG	Beschichtung contact plating	Merkmal mark	Durchmesser D diameter D	Gewicht weight	für Vierkant-Crimpung / for square crimp :			für Vierkerb-Crimpung / for 4 mandrel crimp :			
							Crimpzange crimp tool	Crimpbacken crimping dies	Kontaktaufnahme contact locator	Crimpzange crimp tool	Einstellhorn setting gauge	Kontaktaufnahme contact locator	
N 02 025 0055 1		0,14-0,37 mm <sup>2</sup>	26-22	Ag (silver)	no groove	∅ 2,7	1,6 g	TA 0000 oder / or TA 0500 oder / or EK 15/50 ML (Klauke)	TA 0000 144	TA 0010 146 0006	TB 0001	≤0,25mm <sup>2</sup> : ∅ 1,3 0,37mm <sup>2</sup> : ∅ 1,55	TB 0000 146 0006
N 02 025 0035 1		0,5 mm <sup>2</sup>	20		∅ 2,6	∅ 1,55							
N 02 025 0036 1		0,75-1 mm <sup>2</sup>	18		1 groove	∅ 1,55							
N 02 025 0037 1		1,5 mm <sup>2</sup>	16		2 grooves	∅ 1,8							
N 02 025 0038 1		2,5 mm <sup>2</sup>	14		3 grooves	∅ 1,8							
N 02 025 0059 1		3 mm <sup>2</sup>	12		1 wide groove	∅ 1,8							
N 02 025 0039 1		4 mm <sup>2</sup>	12		no groove	∅ 2,0							
N 02 025 0055 2		0,14-0,37 mm <sup>2</sup>	26-22	Au (gold)	no groove	∅ 2,7	1,6 g	TA 0000 oder / or TA 0500 oder / or EK 15/50 ML (Klauke)	TA 0000 144	TA 0010 146 0006	TB 0001	≤0,25mm <sup>2</sup> : ∅ 1,3 0,37mm <sup>2</sup> : ∅ 1,55	TB 0000 146 0006
N 02 025 0035 2		0,5 mm <sup>2</sup>	20		∅ 2,6	∅ 1,55							
N 02 025 0036 2		0,75-1 mm <sup>2</sup>	18		1 groove	∅ 1,55							
N 02 025 0037 2		1,5 mm <sup>2</sup>	16		2 grooves	∅ 1,8							
N 02 025 0038 2		2,5 mm <sup>2</sup>	14		3 grooves	∅ 1,8							
N 02 025 0059 2		3 mm <sup>2</sup>	12		1 wide groove	∅ 1,8							
N 02 025 0039 2		4 mm <sup>2</sup>	12		no groove	∅ 2,0							

Prüfstiftset / calibration pin set: TP 0000 146 1100

General Characteristics	Standard	Value
contacts termination technique		crimp
contacts type		machined contacts
cable type	IEC 60228	class 5 (fine-strand)
stripping length		6,5 <sup>+1</sup> <sub>-0</sub>
Electrical Characteristics	Standard	Value
rated current T <sub>amb</sub> = 40 °C		depending on contact insert
current carrying capacity	IEC 60512-5-2	see derating curve
contact resistance	IEC 60512-2-1	≤ 5 mΩ
Climatical Characteristics	Standard	Value
operating temperature	IEC 60068-1	-40 - +125 °C
Mechanical Characteristics	Standard	Value
mechanical operation	IEC 60512-9-1	≥500 mating cycles
mating/unmating force (in new condition)	IEC 60512-16-5	≤10 N
Materials	Standard	Value
contact material		copper alloy
contact plating contact area		Ag (silver) / Au (gold)
contact plating termination area		Ag (silver) / Au (gold)

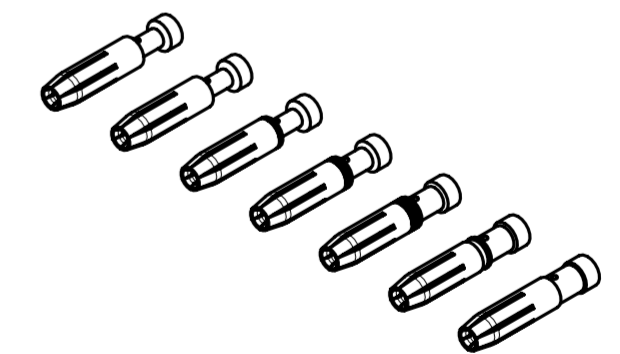
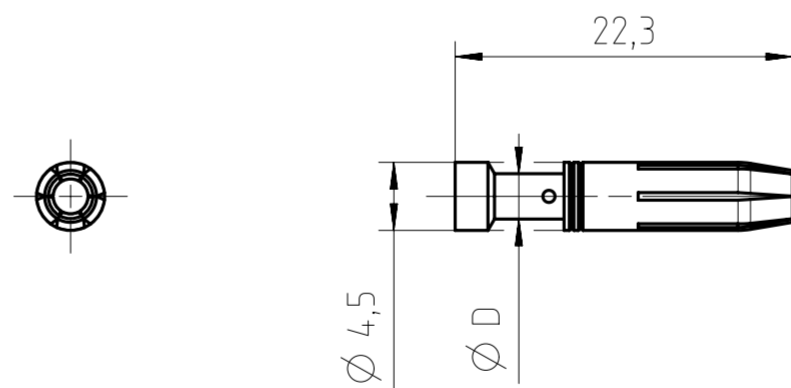

Alle technischen Daten wurden unter Laborbedingungen ermittelt und können im Praxisbetrieb abweichen. Es handelt sich bei den Angaben weder um Beschaffenheits- noch um Haltbarkeitsgarantien. All technical data have been measured in a laboratory environment and can be different during practical usage of the product. Any product information is for descriptive usage only and not legally binding, particularly the information does not constitute or provide any legal guarantees ("Beschaffenheitsgarantie" or "Haltbarkeitsgarantie").

Gewicht (errechnet) / Calc. WT.:	Zul. Abw./Tolerances:	Maßstab / Scale: 2:1 (1:1)	A2	
Prüfmaß / Testdimension	ISO 2768-m	CUSTOMER DRAWING		
Teilindex / Partindexnumber:	DIN / ISO 13715	Buchsenkontakte ∅2,5 mm socket contacts ∅2,5 mm		
Bagatelle change:	Gez. 31.03.2016 Drawn AZN_NPFEIFFE Status Released Gepr. 01.06.2021 Checked MCARLE	Amphenol Tuchel Industrial GmbH		
04 202100149 22.04.2021 PWÖLF	02 201600572 18.08.2016 PWÖLF	M	N 02 025 003X X	Blatt / Sheet 1
01 201600200 04.04.2016 JHONN				1 Bl.
Index Änderung / Description	Datum / Date	Name	Ers. f. / Replacement for: M-N 02 025 003X X Rev.01	

Weitergabe sowie Vervielfältigung dieser Unterlage, Verwertung und Mitteilung ihres Inhalts nicht gestattet, soweit nicht ausdrücklich zugestanden. Zuwiderhandlungen verpflichten zu Schadenersatz. Alle Rechte für den Fall der Patenterteilung oder Gebrauchsmuster-Eintragung vorbehalten.

Copying of this document and giving it to others and the use or communication of the contents thereof, are forbidden without express authority. Offenders are liable to the payment of damages. All rights are reserved in the event of the grant of a patent or the registration of the utility model or design.



FAI2021-001694