

Copying of this document and giving it to others and the use or communication of the contents thereof, are forbidden without express authority. Offenders are liable to the payment of damages. All rights are reserved in the event of the grant of a patent or the registration of the utility model or design.  
  
 Weitergabe sowie Vervielfältigung dieser Unterlage, Verwertung und Mitteilung ihres Inhalts nicht gestattet, soweit nicht ausdrücklich zugestanden. Zuwiderhandlungen verpflichten zu Schadensersatz. Alle Rechte für den Fall der Patenterteilung oder Gebrauchsmuster-Eintragung vorbehalten.

Teilenummer <i>part number</i>	Anschluss- querschnitt <i>terminal cross-section</i>	Rille 1 <i>groove 1</i>	Rille 2 <i>groove 2</i>	Rille 3 <i>groove 3</i>	d1 (mm)	d2 (mm)	Crimpzange <i>crimp tool</i>	Kontaktaufnahme <i>contact locator</i>	Einstelldorn <i>setting gauge</i>
N 01 040 0010 (1) 	1,5 mm <sup>2</sup>	ja <i>yes</i>	ja <i>yes</i>	nein <i>no</i>	1,7	3	TB 0002	TB 0000 146 0008	∅ 1,8 mm
N 01 040 0011 (1) 	2,5 mm <sup>2</sup>	ja <i>yes</i>	ja <i>yes</i>	ja <i>yes</i>	2,2	3,5	TB 0002	TB 0000 146 0008	∅ 1,8 mm
N 01 040 0012 (1) 	4 mm <sup>2</sup>	nein <i>no</i>	nein <i>no</i>	nein <i>no</i>	2,8	4,1	TB 0002	TB 0000 146 0008	∅ 2,0 mm
N 01 040 0013 (1) 	6 mm <sup>2</sup>	ja <i>yes</i>	nein <i>no</i>	nein <i>no</i>	3,55	5	TB 0002	TB 0000 146 0008	∅ 2,2 mm
N 01 040 0015 (1) 02 	10 mm <sup>2</sup>	nein <i>no</i>	ja <i>yes</i>	ja <i>yes</i>	4,3	5,65	TB 0002	TB 0000 146 0008	∅ 2,8 mm

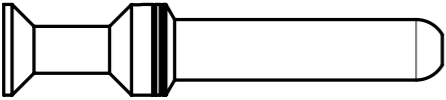
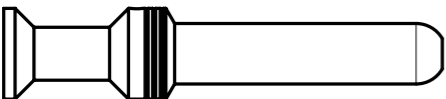
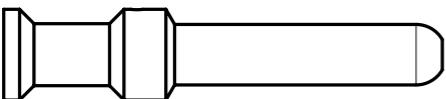
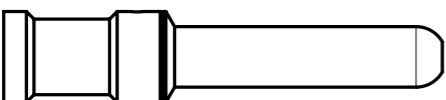
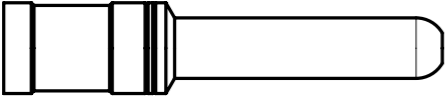
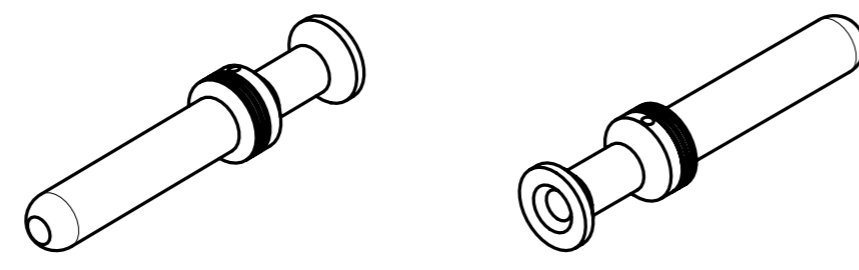
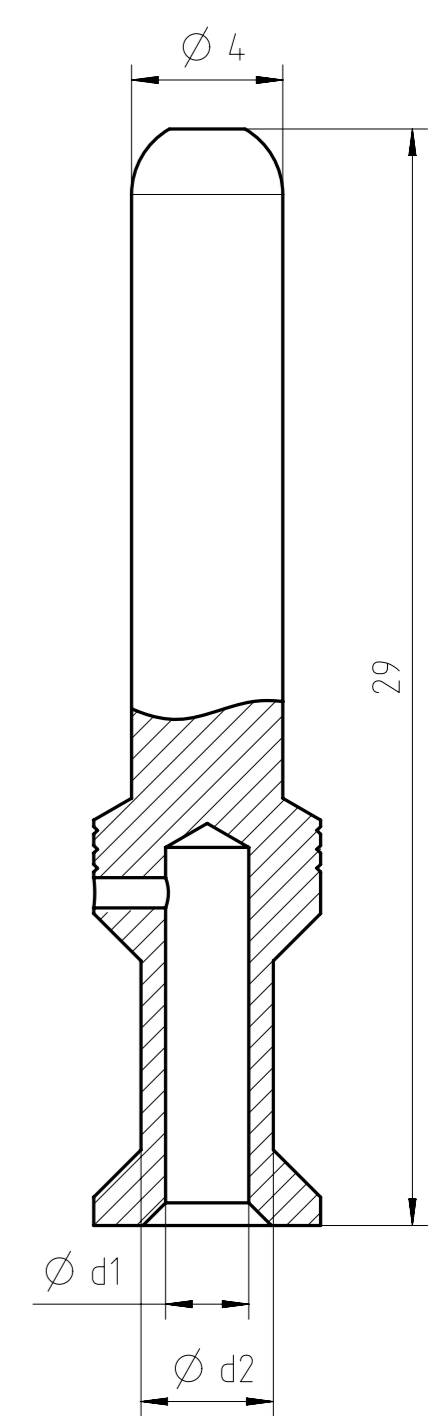

Gewicht (errechnet) / Calc WT: 3,1 g		Zul. Abw./Tolerances:		Maßstab / Scale:	5:1, 2:1	A3
Prüfmaß / Testdimension		ISO 2768-mH		CUSTOMER DRAWING		
Teilindex Partindexnumber		DIN / ISO 13715		Stiftkontakt 4 mm pin contact 4 mm		
		2013 Datum/Date		Name		
		Gez. 29.05.		Bednarczyk		
		Gepr.				
		Checked				
				<b>Amphenol-Tuchel Electronics GmbH</b>		
02 201400046 08.04.14 Holley				M N 01 040 001X (1)		
01 201100639 29.05.13 PB						
Index Änderung/Description		Datum/Date		Name		Blatt/Sheet 1 2 Bl.
				Ers. f. l. Replacement for: -		

Coping of this document and giving it to others and the use or communication of the contents thereof, are forbidden without express authority. Offenders are liable to the payment of damages. All rights are reserved in the event of the grant of a patent or the registration of the utility model or design.  
  
 Weitergabe sowie Vervielfältigung dieser Unterlage, Verwertung und Mitteilung ihres Inhalts nicht gestattet, soweit nicht ausdrücklich zugestanden. Zuwiderhandlungen verpflichten zu Schadensersatz. Alle Rechte für den Fall der Patenterteilung oder Gebrauchsmuster-Eintragung vorbehalten.

Isolationsdurchmesser der Ader $d_A$ <i>insulation diameter of wire <math>d_A</math></i>	Abisolierlänge $a$ <i>strip length <math>a</math></i>	Abstandsmaß Isolation - Stiftkontakt $b$ (nach Crimpung) <i>distance insulation - pin contact <math>b</math> (after crimping)</i>	verwendbare Kontakteinsätze <i>applicable contact inserts</i>		
			Modul F	Q4/2	K6/36
bis max. 5,2 mm <i>up to max. 5,2 mm</i>	$9,5 \pm 1$	0 - 1 mm	C146 10A003 500 15	C146 10A006 500 12	C146 10A042 500 13
ab 5,2 bis max. 7,8 mm <i>from 5,2 up to max. 7,8 mm</i>	$18 \pm 0,5$	8,3 - 9 mm	C146 10A003 501 15	nicht verwendbar <i>not applicable</i>	nicht verwendbar <i>not applicable</i>

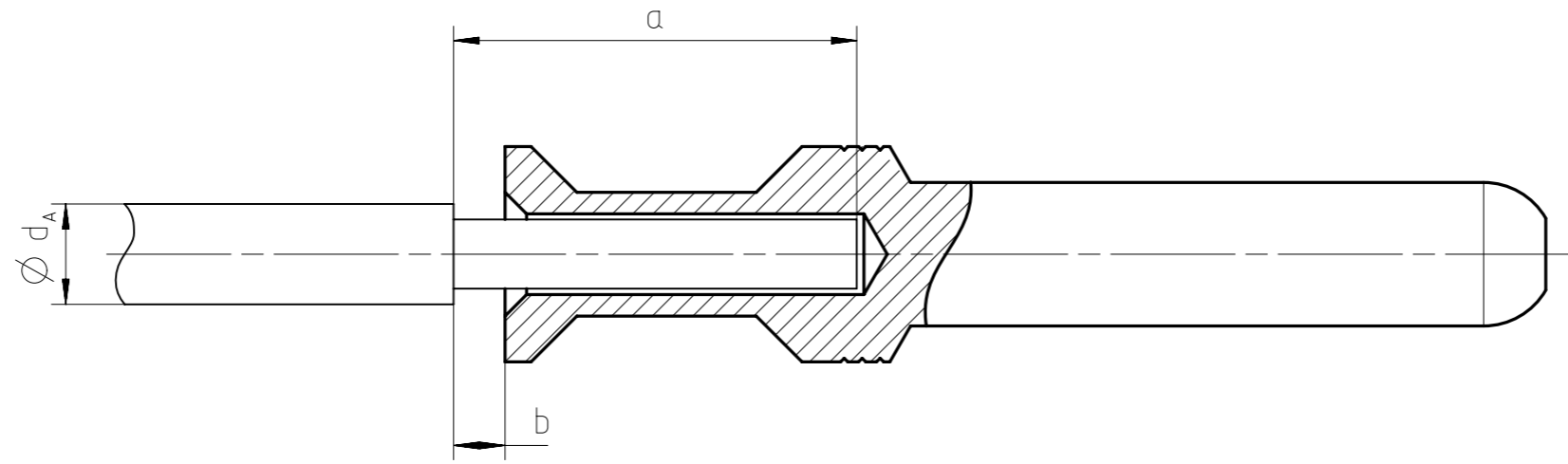

Gewicht (errechnet) / Calc WT: 3,1 g		Zul. Abw./Tolerances:		Maßstab / Scale: 5:1		A3			
Prüfmaß / Testdimension		ISO 2768-mH				CUSTOMER DRAWING			
Teileindex Partindexnumber		2014		Datum/Date		Name		Stiftkontakt 4 mm pin contact 4 mm	
		Gez.		08.04.		Holley			
		Drawn							
		Gepr.							
		Checked							
02		2014-00046		08.04.14		Holley		<b>Amphenol-Tuchel Electronics GmbH</b>	
Index		Änderung/Description		Datum/Date		Name		M N 01 040 001X (1)	
								Blatt/Sheet 2 2 Bl.	
								Ers. f. / Replacement for: <input checked="" type="checkbox"/>	