

Teilenummer part number	Anschluss- querschnitt terminal cross-section	AWG AWG	Merkmal mark	Durchmesser D diameter D	Gewicht weight	für Vierkant-Crimpung / for square crimp :			für Vierkerb-Crimpung / for 4 mandrel crimp :			für B-Crimpung / for F crimp :	
						Crimpzange crimp tool	Crimpbacken crimping dies	Kontaktaufnahme contact locator	Crimpzange crimp tool	Einstelldorn setting gauge	Kontaktaufnahme contact locator	Crimpzange crimp tool	Crimpbacken crimping dies
N 02 036 0004 1 	1,5 mm ²	16	2 grooves	∅ 3	3,0 g	TA 0000 oder / or TA 0500 oder / or EK 15/50 ML (Klauke)	TA 0000 144	TA 0010 145 0005	TB 0002	∅ 1,8	TB 0000 146 0008	-	-
N 02 036 0005 1 	2,5 mm ²	14	3 grooves	∅ 3,4									
N 02 036 0001 1 	4 mm ²	12	no groove	∅ 3,9									
N 02 036 0002 1 	6 mm ²	10	1 groove	∅ 4,6									
N 02 036 0003 1 	10 mm ²	8	2 grooves	∅ 5,9									
N 02 036 0021 1 	16 mm ²	6	no groove	∅ 8,3	5,0 g	-	-	-	-	-	-	EK 12042 (Klauke) oder / or AHPW 400C (Neko)	TE 0600 063

Prüfstiftset / calibration pin set: TP 0000 146 1200

General Characteristics	Standard	Value
contacts termination technique		crimp
contacts type		machined contacts
cable type	IEC 60228	class 5 (fine-strand)
stripping length		10 ⁺¹ ₋₀
Electrical Characteristics	Standard	Value
rated current T _{amb} = 40 °C		depending on contact insert
current carrying capacity	IEC 60512-5-2	see derating curve
contact resistance	IEC 60512-2-1	≤ 5 mΩ
Climatical Characteristics	Standard	Value
operating temperature	IEC 60068-1	-40 - +125 °C
Mechanical Characteristics	Standard	Value
mechanical operation	IEC 60512-9-1	≥10000 mating cycles
mating/unmating force (in new condition)	IEC 60512-16-5	≤25 N
Materials	Standard	Value
contact material		copper alloy
contact plating contact area		Ag (silver)
contact plating termination area		
clip material		copper alloy
clip plating		Ni (nickel)

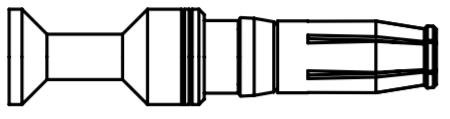
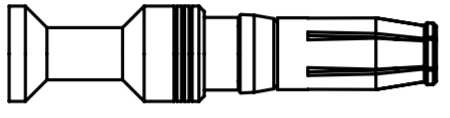
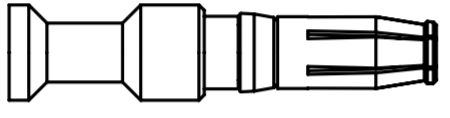
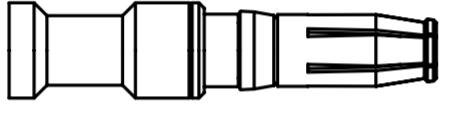
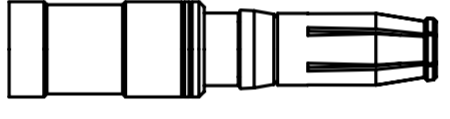
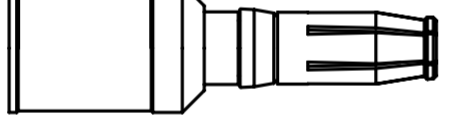
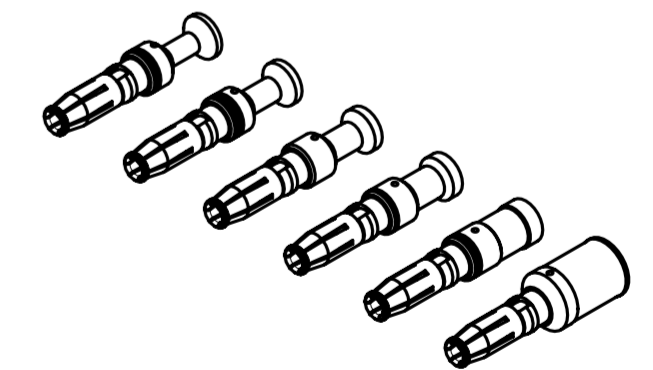
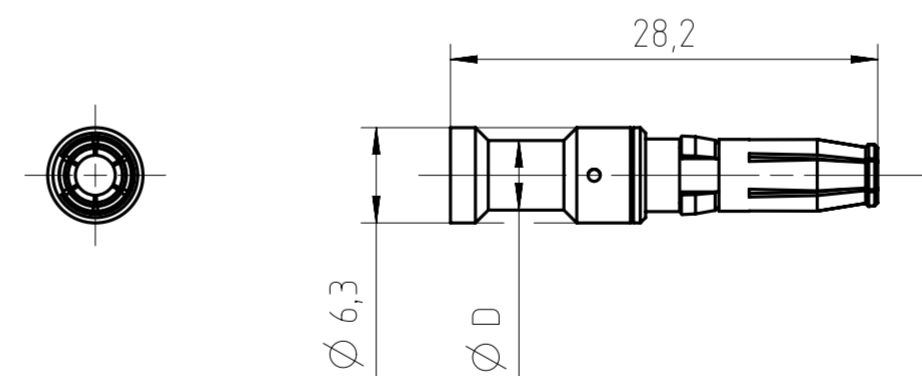

Alle technischen Daten wurden unter Laborbedingungen ermittelt und können im Praxisbetrieb abweichen. Es handelt sich bei den Angaben weder um Beschaffenheits- noch um Haltbarkeitsgarantien. All technical data have been measured in a laboratory environment and can be different during practical usage of the product. Any product information is for descriptive usage only and not legally binding, particularly the information does not constitute or provide any legal guarantees ("Beschaffenheitsgarantie" or "Haltbarkeitsgarantie").



Weitergabe sowie Vervielfältigung dieser Unterlage, Verwertung und Mitteilung ihres Inhalts nicht gestattet, soweit nicht ausdrücklich zugestanden. Zuwiderhandlungen verpflichten zu Schadenersatz. Alle Rechte für den Fall der Patenterteilung oder Gebrauchsmuster-Eintragung vorbehalten.

Copying of this document and giving it to others and the use or communication of the contents thereof, are forbidden without express authority. Offenders are liable to the payment of damages. All rights are reserved in the event of the grant of a patent or the registration of the utility model or design.

Gewicht (errechnet) / Calc. WT.: 3,05 g	Zul. Abw./Tolerances:	Maßstab / Scale: 2:1 (1:1)	A2	
Prüfmaß / Testdimension	ISO 2768-mH	CUSTOMER DRAWING		
Teilindex / Partindexnumber:	DIN / ISO 13715	Kontaktbuchse socket contact ∅3,6 mm		
Bagatelle change:	Gez. 20.04.2021 Drawn PWOLFFLE Status Released Gepr. 16.10.2023 Checked MBERTSCH	Amphenol Tuchel Industrial GmbH		
02 202300083 11.08.2023 PWÖLF	M N 02 036 00XX 1		Blatt / Sheet 1	
01 202100147 22.04.2021 PWÖLF	Ers. f. / Replacement for:		1 Bl.	
Index Änderung / Description	Datum / Date	Name		