

Find out more about our products on:  
[www.amphenol-industrial.de](http://www.amphenol-industrial.de)

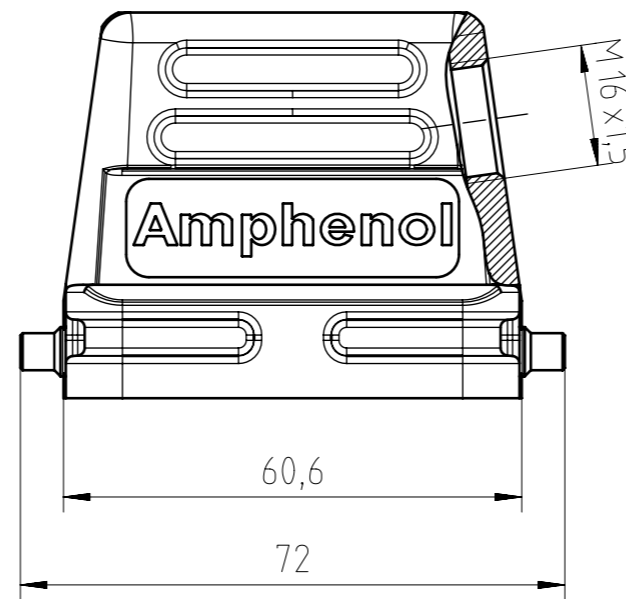
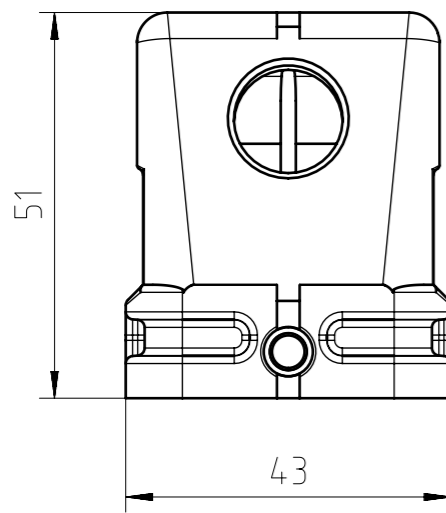
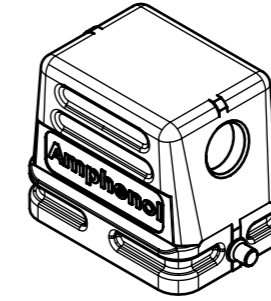
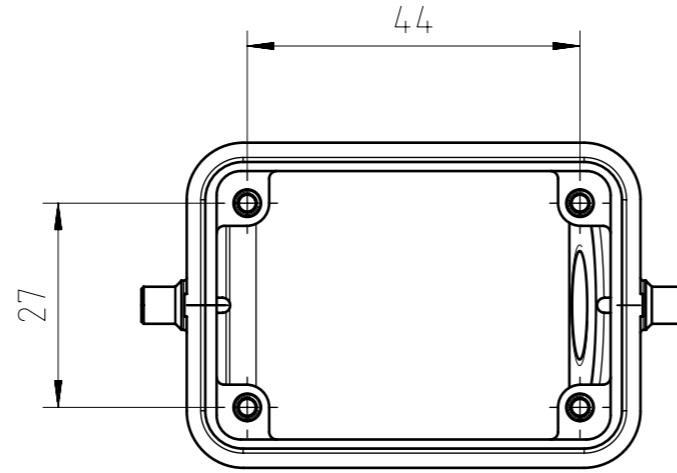

General Characteristics	Standard	Value
Type		hood
Protection class	IEC 60529	IP65 & IP66 & IP67
Locking System	DIN EN 175 301-801 (DIN 43 652)	1 locking lever
Cable entry & position		M16 side
Climatical Characteristics	Standard	Value
Operating temperature	IEC 60068-1	-40°C - +100°C
Mechanical Characteristics	Standard	Value
Mechanical operation	IEC 60512-9-1	≥500 mating cycles
Materials		Value
Housing material		Al (aluminium) alloy
Housing surface		EMC coated
Housing color		grey (similar to RAL 9006)

Gewicht (errechnet) / Calc WT: 87 g		Zul. Abw./Tolerances:		Maßstab / Scale: 1:1 (1:2)		A3			
Prüfmaß / Testdimension		ISO 2768-mH		DIN / ISO 13715		CUSTOMER DRAWING			
Teileindex / Partindexnumber:									
Bagatelle change:						Tüllengehäuse E6 M16 hood E6 M16			
		Gez. 10.02.2014				M C146 11R006 556 1			
		Drawn jhoennige							
		Status Released				Blatt / Sheet 1			
		Gepr. 20.05.2021							
		Checked MBERTSCH				1 Bl.			
05 202100101		21.09.2021		PWOLF		Ers. f. / Replacement for:			
Index		Änderung / Description		Datum / Date					

Alle technischen Daten wurden unter Laborbedingungen ermittelt und können im Praxisbetrieb abweichen.  
Es handelt sich bei den Angaben weder um Beschaffenheits- noch um Haltbarkeitsgarantien.  
All technical data have been measured in a laboratory environment and can be different during practical usage of the product. Any product information is for descriptive usage only and not legally binding; particularly the information does not constitute or provide any legal guarantees ("Beschaffenheitsgarantie" or "Haltbarkeitsgarantie").

Weitergabe sowie Vervielfältigung dieser Unterlage, Verwertung und Mitteilung ihres Inhalts nicht gestattet, soweit nicht ausdrücklich zugestanden. Zuwiderhandlungen verpflichten zu Schadenersatz. Alle Rechte für den Fall der Patenterteilung oder Gebrauchsmuster-Eintragung vorbehalten.

Copying of this document and giving it to others and the use or communication of the contents thereof, are forbidden without express authority. Offenders are liable to the payment of damages. All rights are reserved in the event of the grant of a patent or the registration of the utility model or design.