

Find out more about our products on:
www.amphenol-industrial.de

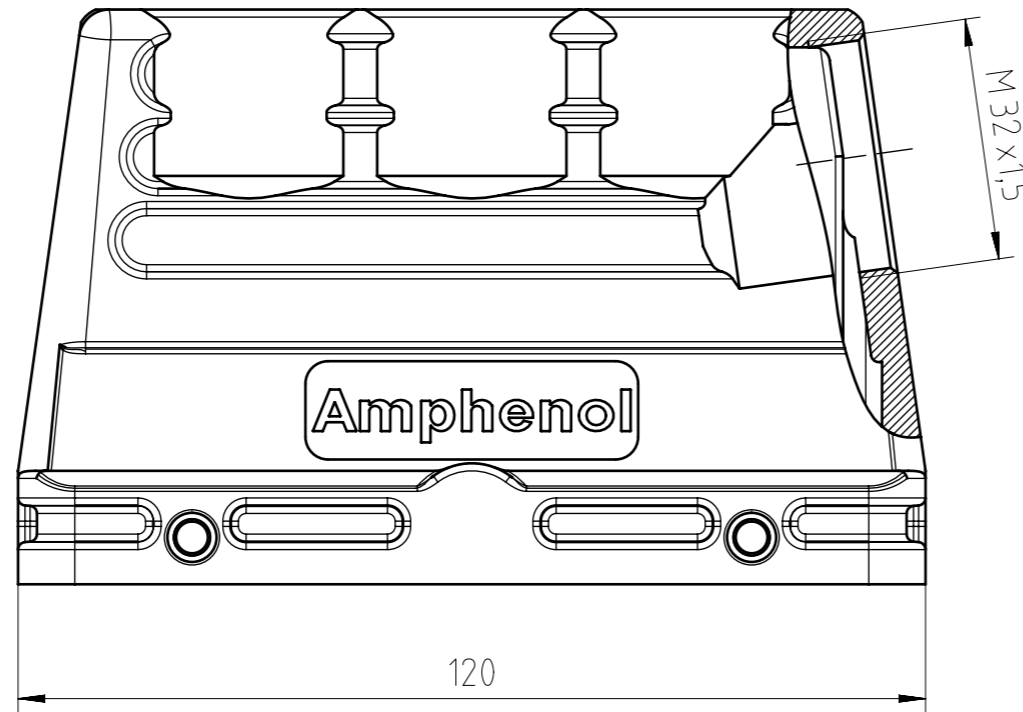
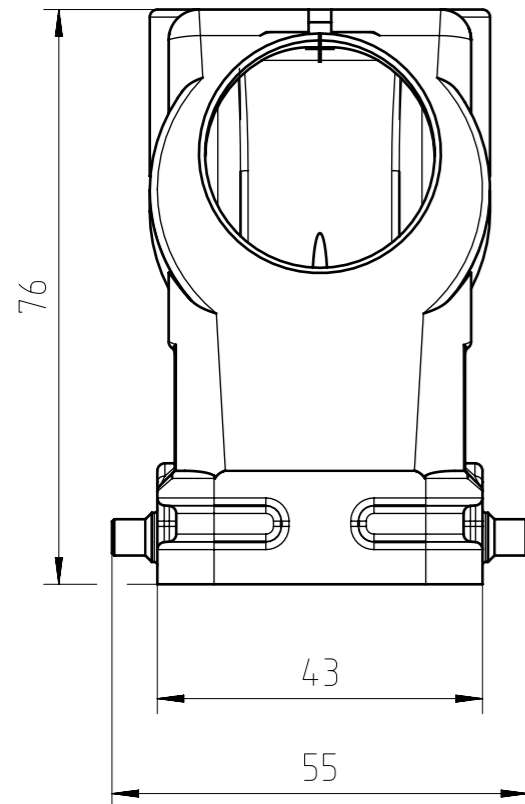
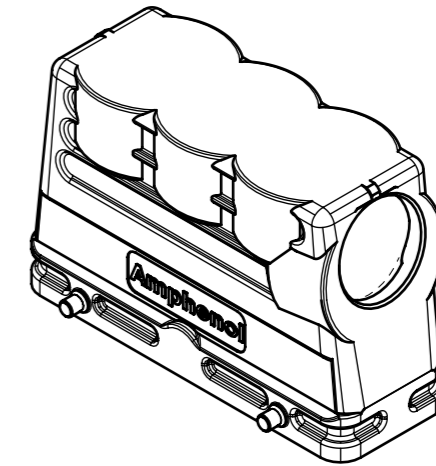
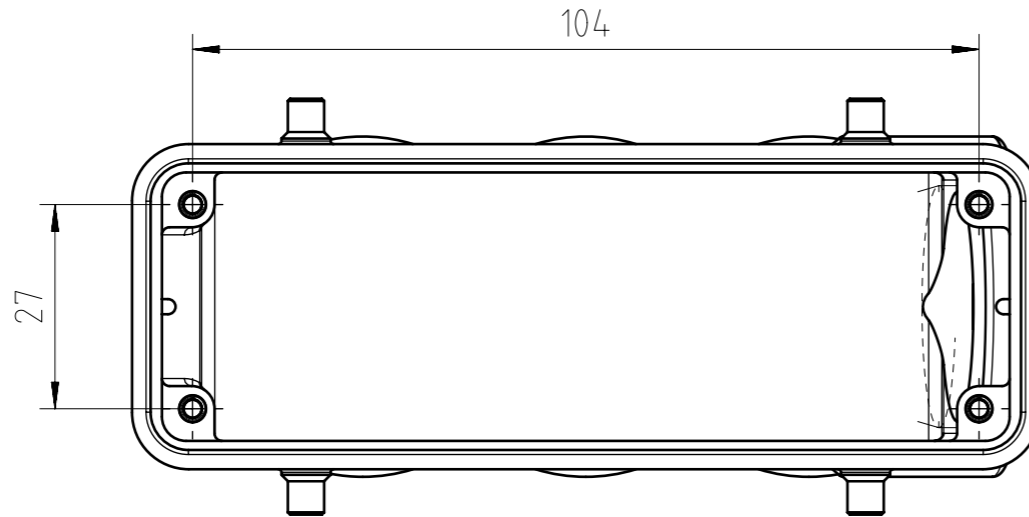

General Characteristics	Standard	Value
Type		hood
Protection class	IEC 60529	IP65 & IP66 & IP67
Locking System	DIN EN 175 301-801 (DIN 43 652)	2 locking levers
Cable entry & position		M32 side
Climatical Characteristics	Standard	Value
Operating temperature	IEC 60068-1	-40°C - +100°C
Mechanical Characteristics	Standard	Value
Mechanical operation	IEC 60512-9-1	≥500 mating cycles
Materials	Value	
Housing material	Al (Aluminium) alloy	
Housing surface	EMC coated	
Housing color	grey (similar to RAL 9006)	

Gewicht (errechnet) / Calc WT: 230 g		Zul. Abw./Tolerances:		Maßstab / Scale: 1:1 (1:2)		A3			
Prüfmaß / Testdimension		ISO 2768-mH		DIN / ISO 13715		CUSTOMER DRAWING			
Teileindex / Partindexnumber:									
Bagatelle change:						Tüllengehäuse E24 M32 hood E24 M32			
		Gez. 16.06.2015				M C146 11R024 500 8			
		Drawn jhoennige							
		Status Released				Blatt / Sheet 1 1 Bl.			
		Gepr. 28.05.2021							
		Checked MBERTSCH				Ers. f. / Replacement for:			
07 202100101		21.09.2021		PWOLF					
Index		Änderung / Description		Datum / Date		Name			

Alle technischen Daten wurden unter Laborbedingungen ermittelt und können im Praxisbetrieb abweichen. Es handelt sich bei den Angaben weder um Beschaffenheits- noch um Haltbarkeitsgarantien. All technical data have been measured in a laboratory environment and can be different during practical usage of the product. Any product information is for descriptive usage only and not legally binding; particularly the information does not constitute or provide any legal guarantees ("Beschaffenheitsgarantie" or "Haltbarkeitsgarantie").

Copying of this document and giving it to others and the use or communication of the contents thereof, are forbidden without express authority. Offenders are liable to the payment of damages. All rights are reserved in the event of the grant of a patent or the registration of the utility model or design.

Weitergabe sowie Vervielfältigung dieser Unterlage, Verwertung und Mitteilung ihres Inhalts nicht gestattet, soweit nicht ausdrücklich zugestanden. Zuwiderhandlungen verpflichten zu Schadenersatz. Alle Rechte für den Fall der Patenterteilung oder Gebrauchsmuster-Eintragung vorbehalten.